

# The No. 1 for Garden Sheds, Boxes, Planting Beds & More



STORAGE  
THE ORIGINAL  
SOLUTIONS

Neo Size 2B, Metallic Silver (with aluminium floor frame, aluminium floor panels, glass panel and double door as accessories)



 100% MADE IN AUSTRIA | PRODUCT CATALOGUE 2025



---

Your continuing  
satisfaction is our  
prime concern here  
at Biohort.

### Dear Customer!

Biohort products offer you the best quality, functionality and security. Our customers especially appreciate the durability and low maintenance of our storage solutions.

Biohort garden sheds have proven their durability in over 30 years of outdoor service. We are an Austrian manufacturing company with highly-trained and skilled workers. Biohort uses only top-quality materials from tested suppliers to manufacture its products. The high-quality steel we use is supplied by the same worldwide renowned Austrian and German steelworks in which German premium car manufacturers place their trust. This is the reason why we can offer our customers a 20-year guarantee against corrosion with a clear conscience.

Let Biohort help you realise your gardening dreams without a care in the world: With the foundation solutions SmartBase and SmartBase<sup>PLUS</sup>, the free delivery and the assembly service, completes our offer to a real complete solution. Find out more on page 5.

Sophisticated design and the high Austrian quality standard applied in the manufacturing process creates products that you will enjoy for decades.

We personally vouch for this.

A handwritten signature in blue ink that reads "J. Priglinger".

Dr. Josef Priglinger  
Company Founder

A handwritten signature in blue ink that reads "Priglinger".

Dipl.-Ing. Maximilian Priglinger, MLS<sup>WU</sup>  
Managing Director

## 4 About Biohort

---

### 8 Garden Sheds

- 10 Neo
- 12 HighLine®
- 14 Panorama®
- 16 AvantGarde®, AvantGarde®ECO
- 18 Europa
- 20 Equipment Locker
- 22 Accessories
- 26 BikeLift®
- 28 Foundation Solutions SmartBase / SmartBase<sup>PLUS</sup>



### 32 Outdoor Living

- 34 CasaNova®, CasaVita®
- 36 Pergola
- 38 Privacy Screen



### 40 Outdoor Boxes

- 42 Romeo® Patio Locker
- 44 StoreMax®
- 46 HighBoard
- 48 LoungeBox®
- 50 StyleBox®
- 52 LeisureTime Box



### 54 Bicycle Storage

- 56 MiniGarage
- 58 StoreMax®
- 60 HighBoard
- 26 BikeLift®



### 62 Wheelie Bin Storage

- 64 Alex®
- 66 Alex® Duo
- 68 StoreMax®
- 70 HighBoard



### 72 Planting Beds

- 74 Raised Bed
- 76 Belvedere® Planting Bed
- 78 Accessories
- 80 DaVinci® Planter Box System



### 82 Gardening Helpers

- 84 MonAmi® Composter
- 85 Charly® Robotic Lawn Mower Garage
- 86 WoodStock® Wood Store



### 88 Detailed Information

- 88 Quality and Sustainability
- 90 Technical Data
- 104 QR Code Pricing Information





### Free Delivery

Dispatched within 2 to 4 days!\* We will deliver your order free of charge directly to your home address (delivery free kerbside). The given address must be accessible for a 38-t lorry (3 m minimum width of access).

\*applies to stocked items, except CasaNova® and CasaVita®



### Assembly Service

Biohort will be delighted to help you find an assembly partner who will assemble your purchase professionally. You can find more information on installation and the recommended prices at:

[www.biohort.com/assembly-service](http://www.biohort.com/assembly-service)



### Assembly Videos

To help with the assembly, we have created short assembly videos for many of our products. You can find them on our YouTube channel:

[www.youtube.com/biohort](http://www.youtube.com/biohort)



# The Biohort All-Around Service Package

## All-In-One Solution

We guarantee our customers long-lasting satisfaction with our high-quality, durable products. In addition, we also offer you a complete service package. Our **customer service department** will always deal with your concerns personally as quickly as possible.

Through our trained **installation partners** we can also guarantee the comfort of a professional installation. The **foundation solutions** SmartBase and SmartBase<sup>PLUS</sup> are available for all shed types and are built faster and cleaner than expensive concrete foundations. Together with our online tools such as the **product configurator**, Biohort offers the most complete service on the market!



## Foundation Solutions

The foundation solutions SmartBase and SmartBase<sup>PLUS</sup> form a stable foundation for Biohort garden sheds, the equipment locker and MiniGarage. The foundations are storm-proof and quick to install.

More information on pages 28 – 31 and at:  
[www.biohort.com/foundation](http://www.biohort.com/foundation)



## Product Configurator

The Biohort 3D-Configurator visualises within a few clicks each product including the individually desired accessories and even calculates the final price. Not enough: the handy augmented reality function allows you to virtually position the product directly in your garden via smartphone or tablet.

[www.biohort.com/configurator](http://www.biohort.com/configurator)



Factory 3 St. Martin i. M.



Factory 1 Neufelden



Factory 2 Herzogsdorf

## Everything **Made in Austria**

Biohort has always produced in Austria, and we are very proud of this fact. There are now three large sites in the western Mühlviertel region of Upper Austria. We have deliberately chosen this

region with a highly skilled workforce. This enables us to produce in the best possible quality.

# This is What We Stand For!



## Quality

- 20 year guarantee, see page 88 for details
- Hot-dipped galvanised, polyamide coated steel
- High-quality fasteners and hinges (e.g. made of stainless steel)
- Lifetime maintenance free
- Rainwater proof
- Production in Austria



## Stability

- Double the plate thickness compared to low-cost providers
- Optimal constructional design
- Storm proof up to 150 km/h, wind force 12\*
- High snow load of up to 150 kg/m<sup>2</sup>\*



## Functionality

- Extensive range of standard equipment
- User friendly
- Large selection of accessories
- Wide range of applications



## Service

- Home delivery included in the price
- Short delivery time
- Assembly manual with photos / 3D illustrations for easy assembly
- Consultation from the Biohort Service Team
- Assembly service available on request



## Security

- Locking mechanism with a cylinder lock
- Non-combustible metal construction

\*Only applies to garden sheds when professionally assembled and anchored.

# A Company With History:

## The Beginnings of Biohort

In the 1970s, we produced garden sheds at the Normstahl plant in Niederwaldkirchen. Later, in 1994, Biohort GmbH was founded and in 1997, Dr. Josef Priglinger took over 100% of Normstahl's Biohort shares.

At the turn of the millennium, Biohort was already listed in most Austrian construction and DIY stores and became increasingly well-known in the German-speaking world. Through the years, Biohort established itself as the market leader in Europa.

## Continuous Product Development

In the early days, we only produced simple garden sheds, metal composters and raised beds. The Europa garden shed was presented in 1996 and is still a classic. More and more different models followed, almost every year Biohort surprises with a new idea. The current portfolio can be found in this catalogue. In addition to the development of new products, we are constantly improving and expanding our existing products. Innovation and quality are our top priorities!



The Europa garden shed in the beginning



# FOR MORE **JOY** IN THE GARDEN





**10** Neo



**12** HighLine®



**14** Panorama®



**16** AvantGarde® & AvantGarde®ECO



**18** Europa



**20** Equipment Locker





**Neo Size 2B, Metallic Silver**  
 (with aluminium floor frame, aluminium floor panels and double door as accessories)

# Neo

## Revolution in Design & Functionality

### The Best From Decades of Experience – The Biohort Top Product

Smooth wall surfaces and the elegant acrylic glass panel in the door characterise the modern look. Additional glass panels can be flexibly installed thanks to a specially developed panel system. To ensure a pleasant atmosphere, the wooden ceiling regulates the humidity along with the optional grey white interior panelling and insulation.

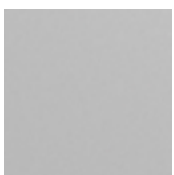

Metallic Silver

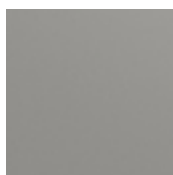

Metallic Quartz Grey

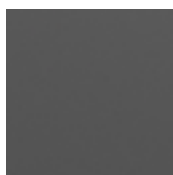

Metallic Dark Grey



**Size 2B, Metallic Dark Grey with Side Canopy**  
 Side and back walls as privacy screens are available separately (see accessories, p. 24).  
 Tip: The glass panel and FloraBoard are also available for the side canopy.



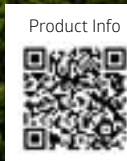

## Advantages

### Security:

- 3-way locking mechanism with stainless steel door handle
- Storm proof up to 150 km/h, wind force 12
- High snow load of up to 150kg/m<sup>2</sup>
- Screw and rivet free surfaces

### Functionality:

- Comfortable door opening with gas spring
- Optional interior panelling and insulation
- Integrated roof gutter

### Standard Equipment:

- Tinted glass in the standard door
- Plywood ceiling with an EPDM roofing membrane
- Rainwater downpipe (2 pcs.)
- Tool holder (2 pcs.)
- Tool hanger (2 pcs.)
- Shelves (2 pcs.)

## Sizes (in cm, exterior dimensions incl. roof overhang)

### Door opening:

Standard door (right door hinge): 83 x 200 cm (W x H) – the standard door can be installed on the sides of the shed.

Double door: 167 x 200 cm (W x H) – the double door can be installed on the sides of the shed from 236 cm.

The blue bar markings indicate the gutters and show the possible attachment sides (from size 2A) of an optional side canopy. See page 24 for details.

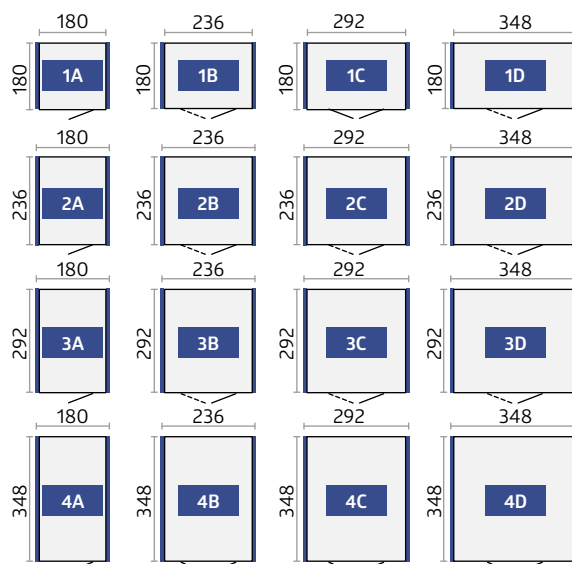

Optional accessories can be found on pages 22 – 31.

Technical data and detailed information can be found on pages 90 – 91.



**HighLine® Size H2, Metallic Dark Grey**  
 (with aluminium floor frame, aluminium floor panels  
 and double door as accessories)

# HighLine®

An Example  
 of Design and  
 Technology

## The HighLine® Garden Shed Fulfils the Highest Standards

The HighLine® impresses with its elegant design and modern flat roof. The integrated all-round skylight sets strong accents and the timeless design fits into any setting. The HighLine® garden shed stands for durability and quality!



Metallic Silver



Metallic Quartz Grey



Metallic Dark Grey

(Roof surface is always in metallic quartz grey)



**HighLine® Size H3, Metallic Silver with Side Canopy**

Side and back walls as privacy screens are available separately (see accessories, p. 24).



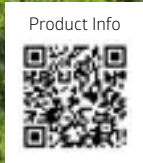

## Advantages

### Security:

- 3-way locking mechanism with stainless steel door handle
- Storm proof up to 150 km/h, wind force 12
- High snow load of up to 150kg/m<sup>2</sup>

### Functionality:

- Integrated gutter with a connection for a 1 1/4" hose
- Gutter with integrated leaf traps fitted to both sides
- Comfortable door opening with gas spring

### Standard Equipment:

- Acrylic glass panels
- Tool holder (2 pcs.)
- Tool hanger (4 pcs.)
- Shelves and support rails (2 pcs. each)

## Sizes (in cm, exterior dimensions incl. roof overhang)

### Door opening:

Standard door (right door hinge): 76 x 182 cm (W x H)

Double door: 155 x 182 cm (W x H)

Further door installation variants: Standard door with door hinge on the left or additional double door. For details see p. 100.

The blue bar markings on the gutters are there to indicate onto which side (from size H2 onwards) the optional side/front canopy can be attached. See page 24 for details. The dotted lines mark the roof overhang.

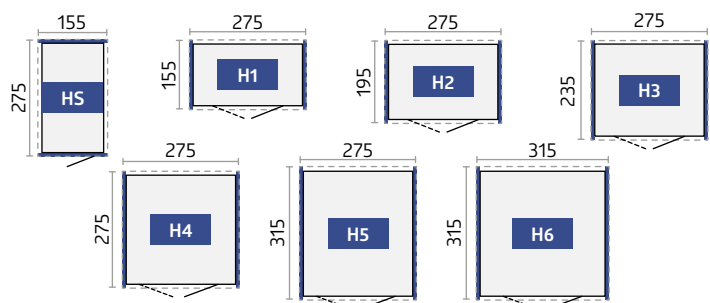

**Tip:** You can rotate the HighLine® from size H2 onwards to suit your own preferences, and the standard door can be installed in any side wall. From size H4 onwards, installing the double doors in the side wall is also possible.

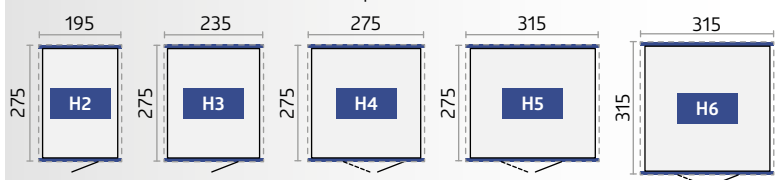

Optional accessories can be found on pages 22 – 31.

Technical data and detailed information can be found on pages 92 – 94.





Panorama® Size P2, Metallic Dark Grey  
(with aluminium floor frame, aluminium floor panels  
and FloraBoard as accessories)

# Panorama®

## Interior Illumination

### The Beauty of Natural Light

The full encircling skylight made of acrylic glass gives our the Panorama® garden shed a lightness in appearance and allows this gable roof model to blend flexibly into any garden environment. The proven Biohort quality of materials and workmanship together with the selection of individual equipment options and the range of sizes available make the Panorama® the perfect garden shed to meet your high demands.



Metallic Silver



Metallic Quartz Grey

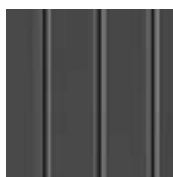

Metallic Dark Grey



**Size P2, Metallic Quartz Grey**

The standard door can be fitted in any side wall from size P2 onwards.

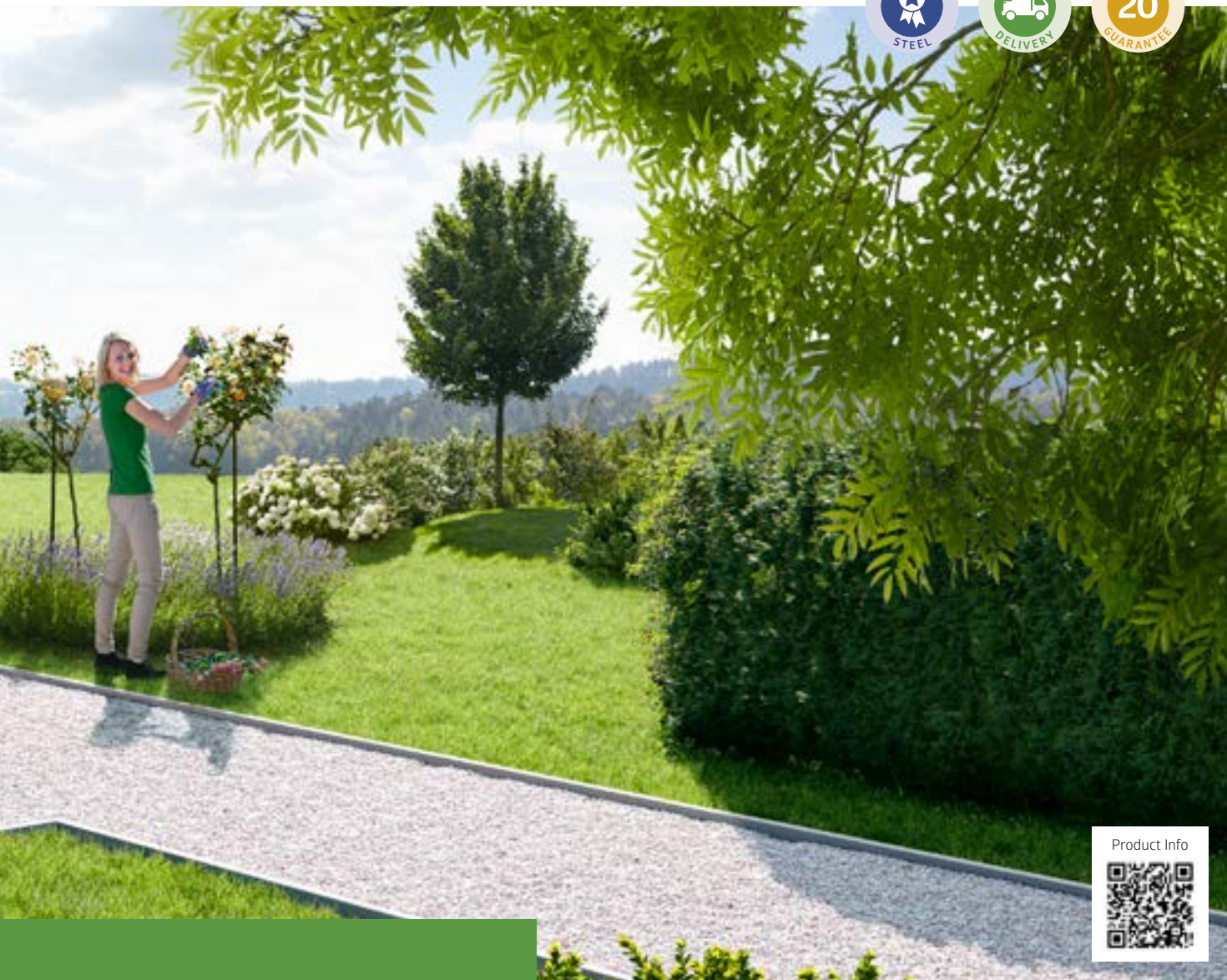

## Advantages

### Security:

- 3-way locking mechanism with stainless steel door handle
- Storm proof up to 150 km/h, wind force 12
- High snow load of up to 150kg/m<sup>2</sup>

### Functionality:

- Integrated gutter with a connection for a 1 1/4" hose
- Gutter with integrated leaf traps fitted to both sides
- Comfortable door opening with gas spring

### Standard Equipment:

- Acrylic glass panels
- Tool holder (2 pcs.)
- Tool hanger (4 pcs.)
- Shelves and support rails (2 pcs. each)

## Sizes (in cm, exterior dimensions incl. roof overhang)

### Door opening:

Standard door (right door hinge): 76 x 182 cm (W x H) – from size P2 onwards, the standard door can be installed in any side wall.

Double door: 155 x 182 cm (W x H) – from size P4 onwards, the double door can be installed in either side wall.

Further door installation variants: Standard door with door hinge on the left or additional double door. For details see p. 100.

The dotted lines mark the roof overhang.

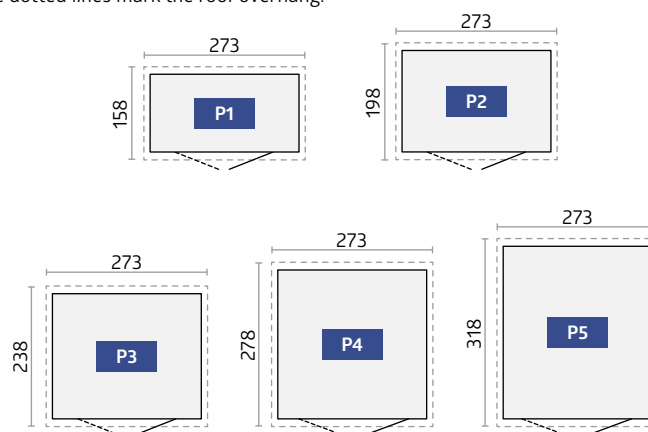

Optional accessories can be found on pages 22 – 31.

Technical data and detailed information can be found on pages 92 – 94.





reddot design award



AvantGarde® Size A5, Metallic Silver  
(with smooth double door, door baskets, aluminium floor frame and aluminium floor panels as accessories)



# AvantGarde®

## Modern Architecture

### Top Quality Pent Garden Shed

The AvantGarde® metal shed lives up to its name in every respect. It impresses with an attractive design that meets the requirements of modern architecture. With its numerous practical advantages for everyday use, it guarantees lasting satisfaction. It is maintenance-free for life and therefore saves money and valuable spare time.



Metallic Silver



Metallic Quartz Grey



Metallic Dark Grey



Size A3, Metallic Dark Grey with Slim Double Door





# AvantGarde® ECO

## ECO Variant at an Attractive Price!



Size A5 in the ECO Variant, Metallic Quartz Grey with corrugated standard door

For particularly price-conscious buyers, we recommend the ECO variant with corrugated door and T-handle cylinder lock.

With integrated organiser system on the inside of the door and door hooks instead of the gas spring. **The ECO variant is supplied without the standard equipment, which makes it so attractive in price.** Door opening and sizes, just like the AvantGarde®. Also available with corrugated double door.

### Advantages

#### Security:

- 3-way locking mechanism with stainless steel door handle / 2-way locking mechanism in the ECO variant
- Storm proof up to 150 km/h, wind force 12
- High snow load of up to 150kg/m<sup>2</sup>

#### Functionality:

- Integrated gutter with a connection for a 1 1/4" hose
- Acrylic glass skylight with roof overhang

#### Standard Equipment\*:

- Tool holder (2 pcs.)
- Tool hanger (4 pcs.)
- Shelves and support rails (2 pcs. each)
- Comfortable door opening with gas spring

\*not included in the ECO variant

### Sizes AvantGarde® and AvantGarde® ECO

(in cm, exterior dimensions incl. roof overhang)

#### Door opening:

Standard door (right door hinge): 76 x 182 cm (W x H)

Double door A1 – A4: 139 x 182 cm (W x H)

Double door A5 – A8: 155 x 182 cm (W x H)

Further door installation variants by AvantGarde®: Standard door with left door hinge. For details see p. 100.

The dotted lines mark the roof overhang.

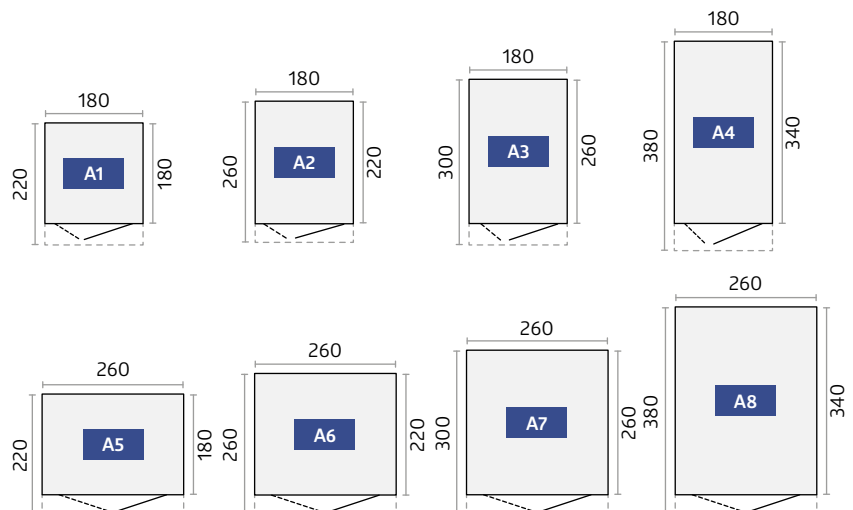

Technical data and detailed information can be found on pages 92 – 94.



Optional accessories can be found on pages 22 – 31.



**Europa Size 3, Metallic Quartz Grey**  
(with aluminium floor frame and aluminium floor panels as accessories)

# Europa

Quality at a Reasonable Price

## Everything Well Organised with the Biohort Classic

The Europa garden shed has been tried and tested for decades and is still very popular. Its high stability and durable materials make it an excellent choice. The functional features simplifies your gardening work and establishes order in your garden. An extensive range of standard features and sophisticated accessories fulfil your needs.



Metallic Silver



Metallic Quartz Grey



Metallic Dark Grey



Dark Green



**Size 4, Metallic Dark Grey with Side Canopy**  
(see accessories p. 24)



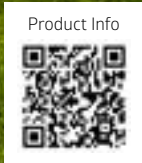

## Advantages

### Security:

- 2-way locking mechanism with T-handle cylinder lock
- Storm proof up to 150 km/h, wind force 12
- High snow load of up to 150kg/m<sup>2</sup>

### Functionality:

- Integrated gutter with a connection for a 1" hose

### Standard Equipment:

- Double door
- Integrated organiser system on the inside of the doors (incl. 6 hooks)
- Tool hanger (4 pcs.)
- Shelves and support rails (2 pcs. each)
- Two additional mounting brackets for wall mounting (by size 2A and size 4A)
- Door hooks to secure the opened door panels

## Sizes (in cm, exterior dimensions incl. roof overhang)

### Door opening:

Double door: 135 x 170 cm (W x H) – from size 2A an off-centre installation of the double door possible, for sizes 2, 3, 4, 5, 6 and 7 side installation of the double door possible.

The dotted lines mark the roof overhang.

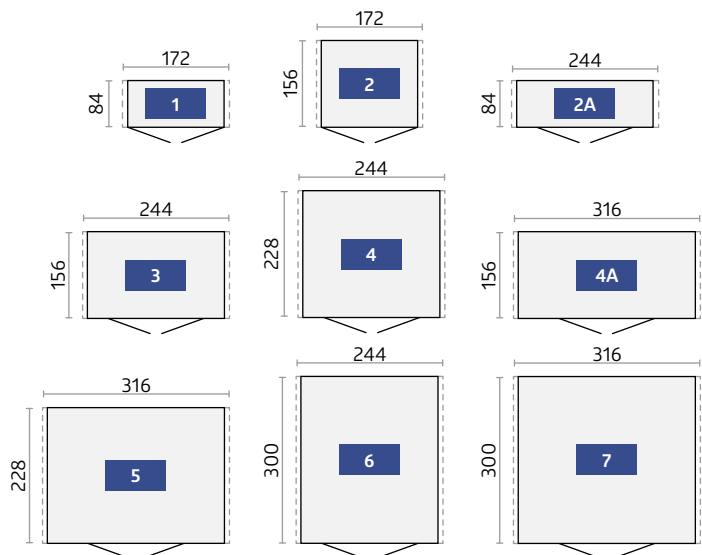

Optional accessories can be found on pages 22 – 31.

Technical data and detailed information can be found on pages 94 – 95.





**Equipment Locker Size 230, Metallic Quartz Grey**  
 (with aluminium floor frame and aluminium floor panels as accessories)

# Equipment Locker

Small but Versatile

## Attractive and Highly Versatile Locker

Where room is scarce, it shows its quality. In the garden, on the terrace, in the garage or on the balcony it organises and stores your tools without restricting your living space. With the Biohort equipment locker you can store garden equipment, barbecue grills, garden furniture, and other similar items protected from rain and theft. It blends harmoniously into its location thanks to seven different sizes and its elegant design.



Metallic Silver



Metallic Quartz Grey

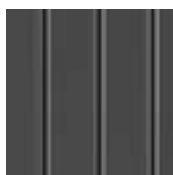

Metallic Dark Grey



**Size 90, Metallic Dark Grey with aluminium floor panels and aluminium floor frame**

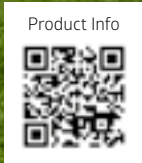
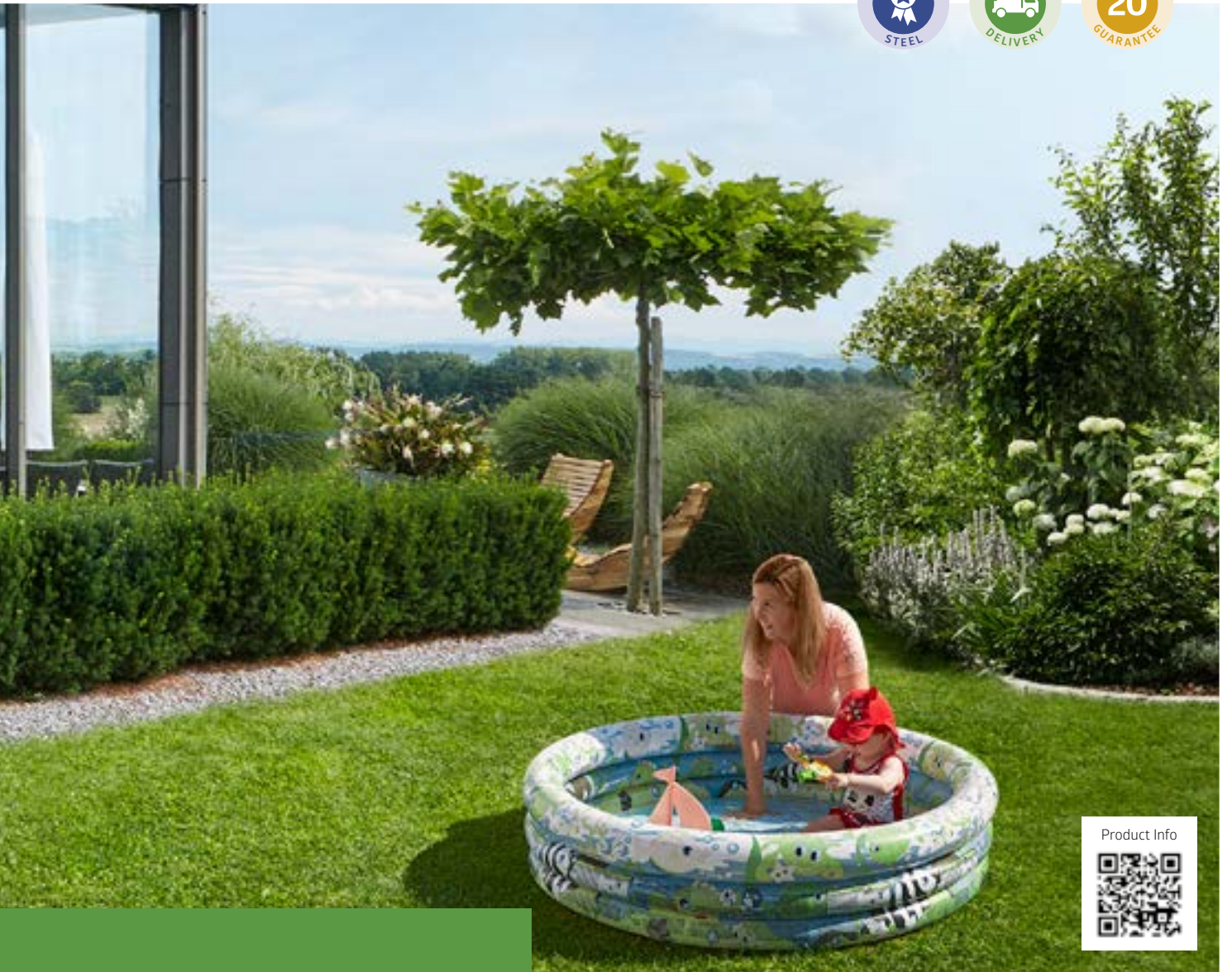

### Advantages

- Invisible, integrated ventilation
- Storm proof up to 150 km/h, wind force 12
- High snow load of up to 150kg/m<sup>2</sup>

### Security:

- 2-way locking mechanism with T-handle cylinder lock
- Fireproof

### Standard Equipment:

- Double door (from size 150)
- Integrated organiser system on the inside of the doors (incl. 6 hooks)
- Tool hanger (4 pcs.)
- Shelves and support rails (2 pcs. each)
- Door hooks to secure the opened door panels

### Sizes (in cm, exterior dimensions)

#### Door opening:

Size 90: 65 x 170 cm (W x H), size 150 – 230: 135 x 170 cm (W x H)

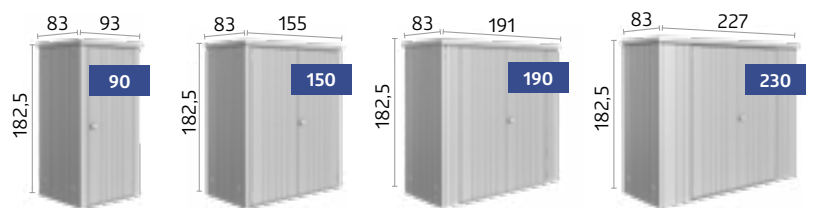

### Double Depth Sizes (in cm, exterior dimensions)

#### Door opening:

135 x 170 cm (W x H)

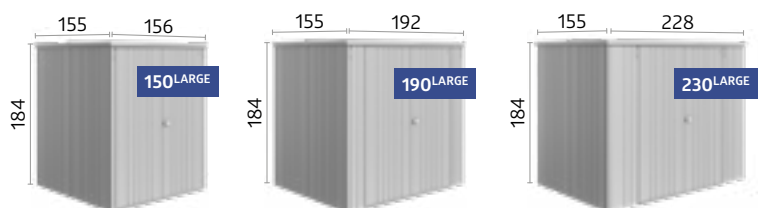







































































































Optional accessories can be found on pages 22 – 31.

Technical data and detailed information can be found on pages 94 – 95.



 **Standard Equipment**

 **Optional Accessories**

	Neo**	HighLine®	Panorama®	AvantGarde®	AvantGarde®ECO	Europa	Equipment Locker
<p><b>01 Shelf Support Rails</b> For mounting accessories such as shelves, shelf baskets, hook set, suspension basket and folding table. <b>Standard Equipment: 2 support rails.</b> (exception Neo garden shed: no support rails are required here, AvantGarde®ECO garden shed: no standard equipment)</p>		 	 	 		 	 
<p><b>02 Shelves</b> Shelves with a depth of 24,5 cm or 43,5 cm are suspended in 2 support rails*. (2 pieces per package) (exception Neo garden shed: shelves of 26 cm or 44,5 cm depth.) Load capacity: 15 kg per shelf. <b>Standard Equipment: 2 shelves</b> (exception AvantGarde®ECO garden shed: no standard equipment)</p>	 	 	 	 		 	 
<p><b>03 Tool Hangers</b> To hang up spades, rakes, garden hoses and other garden tools. (Load capacity: 10 kg). <b>Standard Equipment: 4 tool hangers</b> (exception Neo garden shed: 2 pieces, AvantGarde®ECO garden shed: no standard equipment)</p>	 	 	 	 		 	 
<p><b>04 Tool Holder</b> For mounting on the interior of the door. A maximum of 4 tool holders can be fitted to the door panel. <b>Standard Equipment: 2 tool holders</b> (exception AvantGarde®ECO garden shed: no standard equipment)</p>	 	 	 	 			
<p><b>05 Door Baskets</b> The door baskets can be easily fixed onto the inside of the door. Ideal for storing garden tools, gloves etc. within easy reach (2 pieces per package). Size (W x L x H): 37 x 10 x 9,5 cm, load capacity: 1 kg per door basket</p>							
<p><b>06 Shelf Baskets</b> Shelf baskets are suspended in 2 support rails*. Ideal for storing grass seeds, tins and tools. (2 pieces per package). Size (W x L x H): 72 x 16 x 11 cm, load capacity: 3 kg per shelf basket</p>							
<p><b>07 Hook Set</b> Consists of a combination hook, a handle hook and a shovel hook on a wall rack that is hung between 2 support rails*.</p>							
<p><b>08 Suspension Basket</b> Ideal for storing small objects, includes wall bracket for hanging between 2 support rails*. Sack made of black polyester mesh. Size (W x L x H): 67 x 34 x 20 cm (exception Neo garden shed: 55 x 34 x 20 cm).</p>							
<p><b>09 Folding Table</b> The space-saving folding table is hooked into 2 support rails*. It quickly provides you with a stable work surface. Load capacity max. 30 kg, size (W x L): 69 x 58 cm.</p>							
<p><b>10 Electric Mounting Panel</b> Discreet, hidden cable routing and easy assembly of switches and outlets (electrical equipment in photo not included).</p>							
<p><b>11 LED Light</b> Battery-powered light with motion sensor and permanent light switch; magnetic fixation possible; including USB charging cable.</p>							
<p><b>12 Rainwater Downpipe Set</b> Two downpipes with outlet elbows in the same colour as the shed.</p>							
<p><b>13 Interior Panelling</b> Grey white interior wall panels are simply hooked into the side walls and screwed in place.</p>							
<p><b>14 Insulation</b> The interior wall panelling can also be fitted with 40 mm thick insulation (styrofoam boards), which opens up many new possibilities for the garden shed.</p>							

\*Support rails not included in the delivery (exception Neo garden shed: no shelf support rails are needed).

\*\*Attention: Neo garden shed does not have any corrugations like the other garden sheds, this has not been taken into account in the illustration.

Technical data and detailed information can be found on pages 90-100.





01 Shelf Support Rails  
02 Shelves



03 Tool Hangers



04 Tool Holder



05 Door Baskets



07 Hook Set



08 Suspension Basket



06 Shelf Baskets



09 Folding Table



10 Electric Mounting Panel



11 LED Light



12 Rainwater Downpipe Set



































13 Interior Panelling for Neo Garden Shed



14 Insulation for Neo Garden Shed (unseen)

 **Standard Equipment**

 **Optional Accessories**

	Neo	HighLine®	Panorama®	AvantGarde®	AvantGarde®ECO	Europa	Equipment Locker
<p><b>15 FloraBoard</b> Two rails of the same colour as the shed are attached to the outer wall and the flower boxes can be hung on these at a suitable height. Plastic inserts for easier planting are included in the standard delivery scope. <b>Tip:</b> For the Neo garden shed, the FloraBoard is also available for the side canopy's side or back walls.</p>							
<p><b>16 Window Unit</b> The side wall panel with its metal-frame hinged window (plexiglass) brings even more daylight into the garden shed and provides a clear view of the garden (window opening: 50 x 60 cm).</p>							
<p><b>17 Glass Panel</b> The tinted glass panel is enclosed in a metal frame (Dimensions: 28 x 207 cm) and can be flexibly installed in any side wall, but not next to a door, a corner element or another glass panel. <b>Tip:</b> The glass panel is also available for the side canopy with side or back wall.</p>							
<p><b>18 Gas Spring Set</b> Provides a comfortable door opening. <b>Standard Equipment: 2 pieces (exception AvantGarde®ECO garden shed, Europa and equipment locker).</b> Also available as an optional accessory for AvantGarde®ECO garden shed.</p>							
<p><b>19 Double Door</b> Makes entering and leaving the shed with large tools and equipment easier. The double door panel is equipped on the inside with a rotary lock and with a gas spring (exception: AvantGarde®ECO garden shed, Europa and equipment locker). Neo garden shed standard with glass panel in the right-hand door panel. Exception equipment locke size 90: no double door possible. An additional double door is available as a further door installation variant. For details see p. 100. (exception AvantGarde® garden shed)</p>							
<p><b>20 Additional Door</b> Included in the delivery scope are a stainless steel door handle with standard cylinder (3-way locking mechanism), a gas spring, hinges, two tool holders and the appropriate door frame panels. The door can be hinged* on the right and on request also on the left. For details see p. 100. Neo garden shed: standard with tinted glass panel.</p> <p>AvantGarde®ECO garden shed: Door also available in the more cost-effective ECO variant, corrugated surface, with T-handle cylinder lock (2-way locking mechanism), door hooks, hinges and organiser system on the inside of the door</p> <p>Europa garden shed: double door, corrugated surface, with T-handle cylinder lock (2-way locking mechanism), door hooks, hinges and organiser system on the inside of the door</p>							
<p><b>21 Side Canopy</b> The side canopy can be attached to one or both sides of the Neo garden shed (from size 2A). The width of the side canopy is 300 cm. The aluminium supports are equipped with height-adjustable feet. Two rainwater downpipes are included.</p> <p>The side canopy is fixed to the HighLine® shed (from size H2) on the side with the rain gutter (optionally on one or both sides). It is available in two different sizes. The width of the side canopy size S is 150 cm and for size L 282 cm. The aluminium supports are equipped with height-adjustable feet. The rainwater downpipe is included.</p> <p>The side canopy for the Europa garden shed can be attached on the left, right or both sides. The set includes the supports, a short rainwater downpipe and the fixation material (not available for size 1 and size 2A).</p>							
<p><b>22 Side and Back Walls for Side Canopy</b> You can attach a back wall and/or a side wall to the side canopy of your HighLine® shed (from size H2)/ Neo (from size 2A). They are available in the same colours as the shed.</p>							

\*Exception Neo garden shed: Here the door hinge is only possible on the right.





15 FloraBoard



16 Window Unit



17 Glass Panel for Neo Garden Shed



18 Gas Spring Set



19 Double Door / 20 Additional Door

ECO Variant  
corrugated



21 Side Canopy for Neo Garden Shed



21 Side Canopy for HighLine® / Europa Garden Shed



22 Side and Back Wall for HighLine® Side Canopy



22 Side and Back Wall for Neo Side Canopy



Check your bike: [www.biohort.com/bikelift](http://www.biohort.com/bikelift)

### The BikeLift® Advantages

-  lift function for bikes weighing up to 30 kg
-  lockable bike
-  suitable for tyre widths of up to 77 mm/ 3 inch

The Biohort BikeLift® can be mounted on the wall in the cellar, in the garage or carport in just a few easy steps. It is even easier to install in a Biohort shed – the BikeLift® is simply hooked in there with an additional module as an optional accessory.

**The innovative lift is available in two variants:**  
 standard or swivel mount

### Comfortable lift function for every bike

From e-mountain bike to racing bike – the Biohort BikeLift® pulls any bike vertically up the wall as if by itself. This saves space and is effortless.



#### Hook in

Simply hook the front wheel into the BikeLift®. The hook fits all tyre widths up to 77 mm.

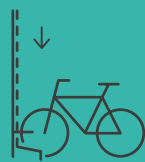

#### Push

A short downward push on the handlebars is enough to activate the automatic lift function.



#### Lift

Thanks to its strong spring force, the BikeLift® pulls every bike (up to a weight of 30 kg) upwards – completely without electricity!



#### Save space

Securely fixed and lockable, the bike hangs vertically on the wall to save space.



## ★ Optional Accessories

		Neo**	HighLine®	Panorama®	AvantGarde®	AvantGarde®ECO	Europa	Equipment Locker
23	<b>BikeLift® Standard</b> The mechanical bicycle lift is simply hooked into the wall profiles and is suitable for bicycles with an outer tyre diameter of up to 29 inches, a tyre width of max. 77 mm, a total height of the rim incl. tyre of max. 77 mm, a maximum bicycle length of 1,95 m and a maximum weight of 30 kg. The end of the rear mudguard and the luggage carrier must not protrude beyond the tyre. Integrated locking eyelet for bicycle locks.	★	★	★	★	★	★	
24	<b>BikeLift® with Swivel Mount</b> For even more space saving, the bike can be folded to the side of the wall thanks to the device. In the Europa garden shed, the BikeLift® with swivel mount can only be mounted centrally on the rear wall.	★	★	★	★	★	★	
25	<b>Threshold Access Ramp</b> For outside and inside, for convenient crossing of the threshold, only possible with aluminium floor frame and double door. Load bearing capacity of max. 200 kg, length: 135 cm (exception Neo garden shed: 163,5 cm).	★	★	★	★	★	★	
26	<b>Bicycle Hanger BikeMax</b> Europa garden shed: height-adjustable in 6 different positions, for bicycles up to 26 inches, with a tire thickness of max. 5 cm and a weight of max. 25 kg. Neo, HighLine®, Panorama®, AvantGarde® and AvantGarde®ECO garden sheds: height-adjustable in 8 different positions and suitable for bikes with up to 29" wheels. Integrated locking eyelet for bicycle locks.	★	★	★	★	★	★	
27	<b>BikeHolder</b> Optimal storage of bicycles thanks to the adjustable retaining clamps. The base plate is hooked into 2 support rails*. Quick and easy securing of the bicycle tyres for a maximum of 3 bicycles per BikeHolder.	★	★	★	★	★	★	

\*Support rails not included in the delivery (exception Neo garden shed: no shelf support rails are needed).

\*\*Attention: Neo garden shed does not have any corrugations like the other garden sheds, this has not been taken into account in the illustration.



23 BikeLift® Standard



24 BikeLift® with Swivel Mount



25 Threshold Access Ramp



26 Bicycle Hanger BikeMax



27 BikeHolder

Technical data and detailed information can be found on pages 91 – 100.

# Conventional Foundation Solutions\*

More information in foundation brochure and at: [www.biohort.com/foundation](http://www.biohort.com/foundation)

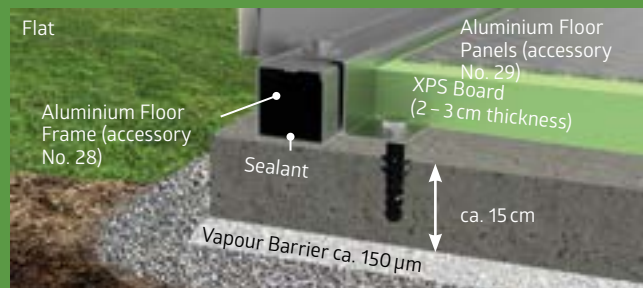

## Concrete Foundation

A reinforced concrete foundation slab on a gravel base is an optimal, but also expensive foundation. With this type of foundation, you must also make sure that no water can penetrate into the shed at ground level. The offset foundation with a circumferential step of 2 cm x 7 cm is the ideal design for this (aluminium floor frame and aluminium floor panels cannot be used). As an alternative to the rebated concrete foundation slab surface, a continuous flat concrete slab can also be poured.

The available **aluminium floor frame** accessory makes it easier to level out any unevenness in the foundation and as well as fitting a sealing joint. The aluminium floor frame also allows the use of the **aluminium floor panels** which can be underlaid with XPS hard foam boards. The XPS hard foam boards not included in the delivery.

## Point Foundation

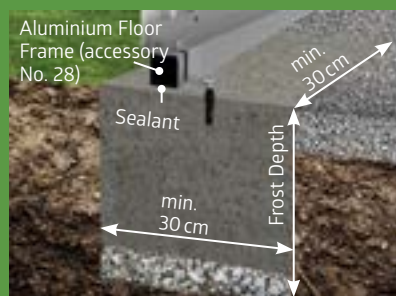

Another option for erecting garden sheds on uneven ground is a point foundation in conjunction with an **aluminium floor frame**.

## Paving Slabs

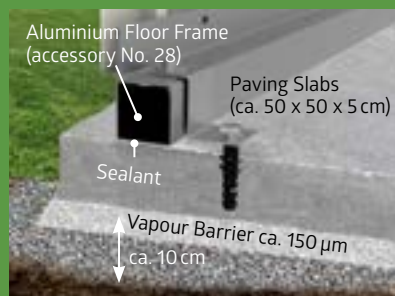

A good and inexpensive solution are paving slabs on a gravel base. We strongly recommend the use of the **aluminium floor frame**.

## Floor Frame

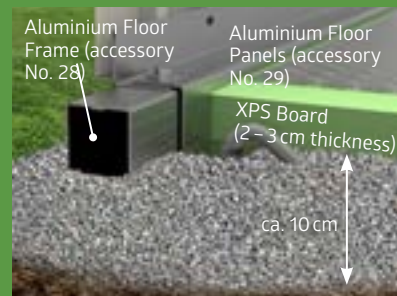

With the **aluminium floor frame** you can also set up and anchor the shed on a gravel bed (ground anchors available as accessory). The **aluminium floor panels** (accessory) serve as a functional floor and are underlaid with XPS hard foam boards (XPS hard foam boards not included in the delivery).

\*non-binding recommendations for all garden sheds, equipment lockers and MiniGarage

# Biohort SmartBase Solutions

Detailed information on the SmartBase and SmartBase<sup>PLUS</sup> can be found on pages 29-31.



## ★ Optional Accessories

		Neo	HighLine®	Panorama®	AvantGarde®	AvantGarde®ECO	Europa	Equipment Locker
<b>28</b>	<p><b>Aluminium Floor Frame</b></p> <p>It gives the shed the necessary stability even without a concrete foundation. If the floor frame is laid directly on a gravel base (approx. 10 cm gravel, without foundation or slabs), ground anchors are required for securing to the ground. These are available as accessories – please refer to the technical data for the number of anchors. Storm resistance must be ensured by the customer for this foundation solution.</p>	★	★	★	★	★	★	★
<b>29</b>	<p><b>Aluminium Floor Panels</b></p> <p>Depending on the size of the house, the high-quality aluminium chequer plate floor consists of several segments including connecting profiles. To ensure the optimal fitting, the aluminium floor frame is necessary (see above). Underlayment with a fill or XPS hard foam boards in a thickness of approx. 2-3 cm recommended (not included in the scope of delivery).</p>	★	★	★	★	★	★	★
<b>30</b>	<p><b>SmartBase</b></p> <p>The perfect floor for solid ground (concrete or paved surfaces). Light ground irregularities of up to 4 cm can be compensated. <b>See details on next page.</b></p>	★	★	★	★	★	★	★
<b>31</b>	<p><b>SmartBase<sup>PLUS</sup></b></p> <p>Optimum solution for slopes and lawns, patented system with ground screws to compensate for slopes of up to 15 cm. <b>See details on next page.</b></p>	★	★	★	★	★	★	★



28 Aluminium Floor Frame



29 SmartBase  
See details on next page.

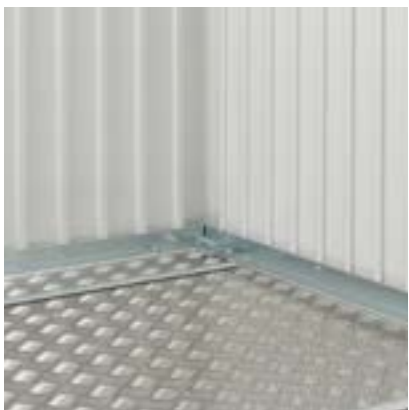
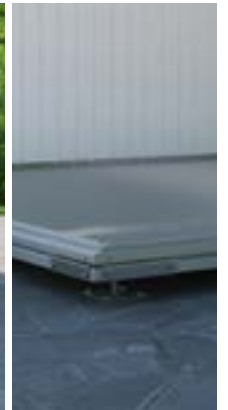

30 Aluminium Floor Panels



31 SmartBase<sup>PLUS</sup>  
See details on next page.





Adjustable Feet



Height Adjustment with Adjustable Feet



Rainwater Barrier

# SmartBase

## Perfect for Hard Surfaces

The Biohort SmartBase Foundation is the ideal foundation for concrete or paved areas. It consists of high-quality aluminium boards, a special foundation frame and height-adjustable feet. So light ground irregularities of up to 4cm can be compensated.

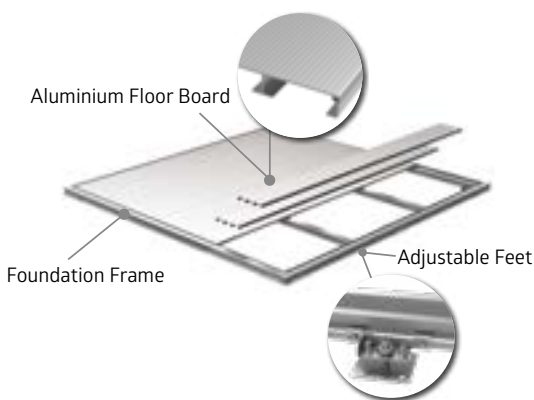

## Advantages

- Compensation of unevenness through adjustable feet
- Easy to remove if necessary
- Precisely fitted to all Biohort garden sheds, the Equipment Lockers and the MiniGarage
- Storm proof
- Load bearing capacity max. 200 kg/m<sup>2</sup>

## Standard Equipment:

- Aluminium floor boards with grooved surface
- Specially designed foundation frame
- Galvanised adjustable feet
- Adjustable feet with height adjustment
- Integrated water barrier to protect against water ingress

**Floor frame and floor panels are no longer necessary!**

**Time of assembly:** 1 – 2 hours for two (depending on skill and product).

**Tools required:** spirit level, drill, open ended spanner SW13 and SW24.

1. Frame assembly
2. Connection of adjustable feet and frame alignment
3. Fixing the adjustable feet to the subsurface
4. Fixing of aluminium floor boards

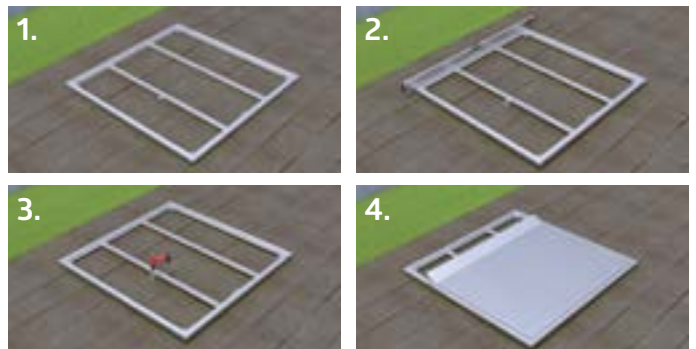





Height Adjustment with Ground Screws

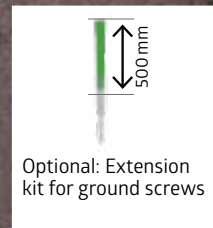

Optional: Extension kit for ground screws



Rainwater Barrier

# SmartBasePLUS

## Optimal Solution for Slopes and Lawns

Unlike the SmartBase foundation, the patented SmartBase<sup>PLUS</sup> system includes ground screws instead of adjustable feet. These are screwed directly into the ground and can compensate for slopes of up to 15 cm (extensions are available on request for larger height differences). For this, the soil should be compact and free of large stones.

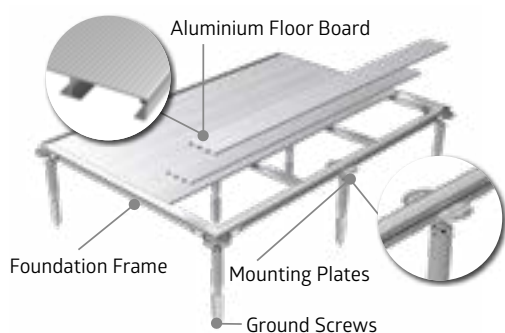

### Advantages

- Little excavation
- Gravel base is not necessary
- Compensation of unevenness through ground screws
- Easy to remove if necessary
- Precisely fitted to all Biohort garden sheds, the Equipment Lockers and the MiniGarage
- Storm proof
- Load bearing capacity max. 200 kg/m<sup>2</sup>

### Standard Equipment:

- Aluminium floor boards with grooved surface
- Specially designed foundation frame
- Galvanised ground screws
- Multi-adjustable mounting plates
- Including manual screw-in driver
- Integrated water barrier to protect against water ingress

Floor frame and floor panels are no longer necessary!

**Time of assembly:** 2 – 4 hours for two (depending on skill and product).

**Tools required:** hammer drill, drill bit Ø 40 x 570 mm, spirit level, drill, open-end spanner SW13 and SW24, shovel.

1. Site preparation and ground screw insertion
2. Attachment and levelling of mounting plates
3. Positioning and attachment of frame
4. Fixing of aluminium floor boards



Technical data and detailed information can be found on pages 90 – 95 and 100.

# THE OASIS OF RELAXATION

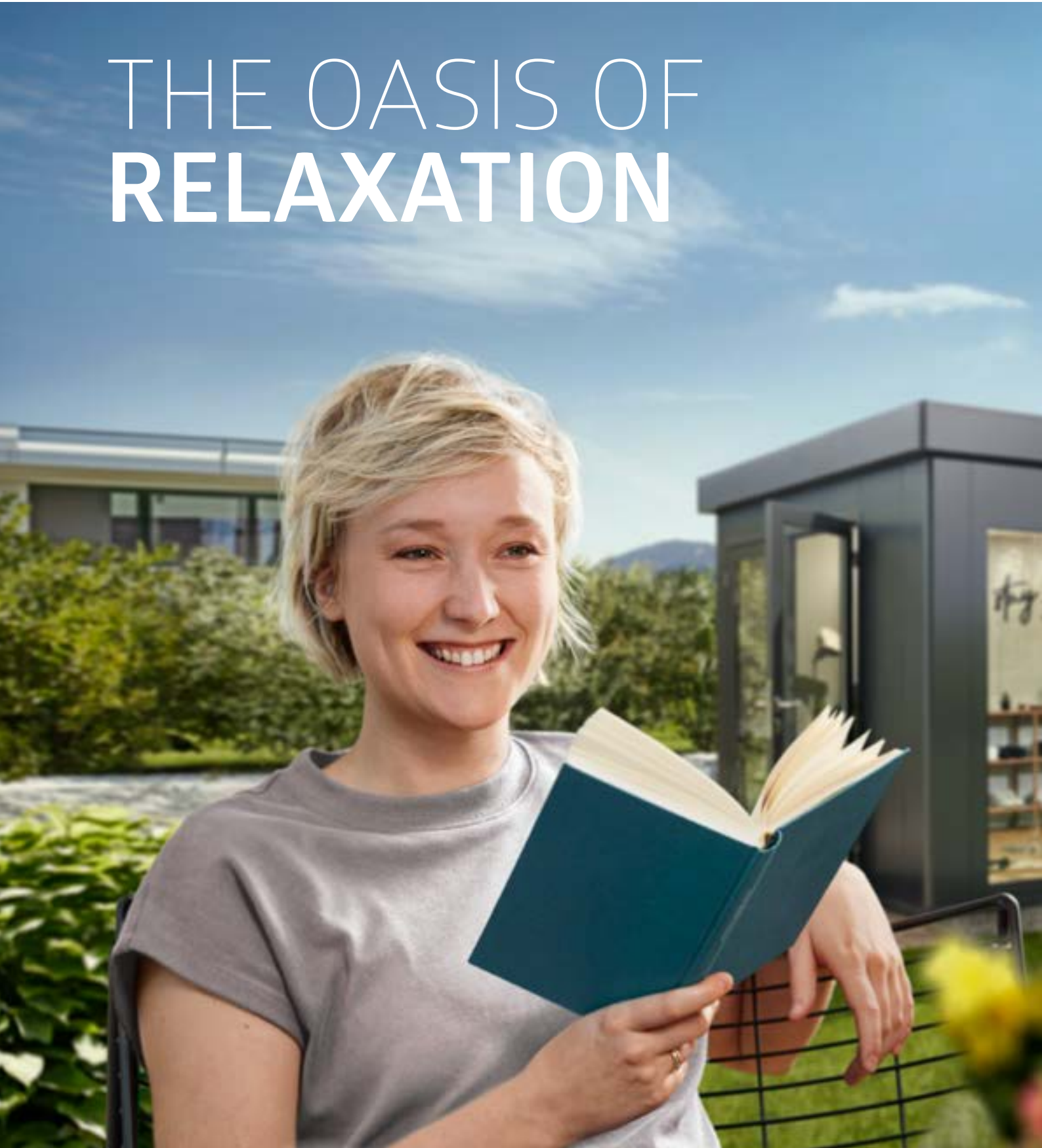





**34** CasaNova® & CasaVita®



**36** Pergola



**38** Privacy Screen



Optional Glass Elements

CasaNova® 3x5, Metallic Dark Grey  
(double door, external lighting and two glass elements as accessories)

# CasaNova®

Design, Customised  
to Your  
Requirements

## The High End Metal Building with Insulated Side Walls

Whether as a garden shed, workshop or hobby room – the CasaNova® insulated design outbuilding demonstrates unique flexibility with a wide range of configuration options and adapts exactly to your requirements. Regardless of whether you are looking for functional storage space or want to create a usable outdoor space: with the CasaNova® you can make your wish come true at a unique quality level.



Metallic Quartz Grey

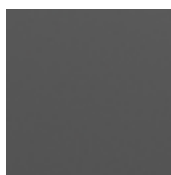

Metallic Dark Grey



**Insulated Side Wall / Door Panel**  
Sandwich element with 40 mm polystyrene core (EPS W20)





## Advantages

- Sandwich element with 40 mm core made of polystyrene (EPS W20)
- Screw and rivet free surfaces

## Security:

- Locking mechanism with stainless steel door handle
- Roof or snow load of up to 215 kg/m<sup>2</sup> (minus roof loading such as greenery)

## Functionality:

- Easy to heat thanks to thermal insulation; U-value of side walls: 0,76 W/(m<sup>2</sup>K)
- Door hinge position on the left or right available
- Large selection of accessories
- Ventilation via acrylic glass panel which can be opened
- Comfortable door opening with gas spring

Product Info



Configure your CasaNova® now!  
[www.biohort.com/configurator](http://www.biohort.com/configurator)

## An Outbuilding in Various Sizes With Customised Options



### CasaNova® – Your High Quality Utility Room

Thanks to the modular construction, there are no limits to your wishes. Doors and windows can be positioned freely according to your expectations. Available from 3x2 m to 4x6 m.

**Hobby Room**  
CasaNova® 3x4, Metallic Dark Grey



### CasaVita® – Your Extended Living Space

The ultimate in outdoor living comfort: CasaVita®. Crafted with precision and built to last, this outbuilding redefines elegance and functionality in your garden oasis. Only available by selected dealers. Sizes from 3x2,5 m to 4x5,5 m.

**Home Gym**  
CasaVita® 3x4,5, Metallic Dark Grey

NEW



Pergola 4 x 3, Metallic Quartz Grey

# Pergola

## Shade and Open Space

### For Unique Moments in Your Garden

A high-quality pergola is the centrepiece of an outdoor area. Not only does it provide shade, it also provides the perfect space for your next garden party or summer brunch. The timeless design and first-class workmanship are a given at Biohort.



Metallic Quartz Grey / Metallic Silver\*



Metallic Quartz Grey



Metallic Dark Grey / Metallic Silver\*



Metallic Dark Grey

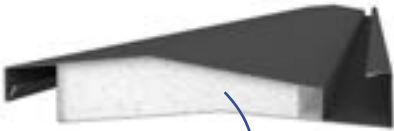

**Louver Structure**  
Sandwich construction with Peripor core

(\*colour of the roof louvres)





## Advantages

- Less heat radiation thanks to the sophisticated design and sandwich construction of the louvres
- Significantly reduced noise generation
- Accessories can be easily retrofitted
- Robust design in Biohort quality

## Functionality:

- 130° adjustable louvres control the shading
- Rainwater drainage integrated in the uprights

## Standard Equipment:

- Manually adjustable louvres
- Preparation for LED lighting (channel with cover)



Product Info



## Sizes (in cm)

Height:  
255 cm

The dotted lines indicate the footprint.

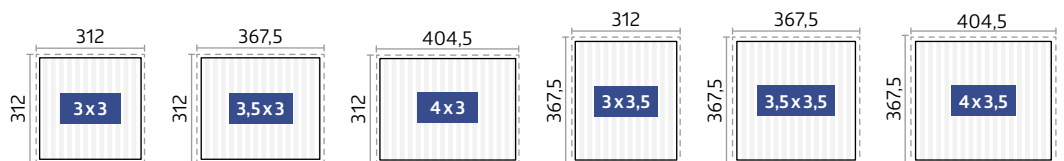

## ★ Optional Accessories



### Louvred Side Wall

Manually adjustable. For protection from wind and weather. When using manual drive, installation on the side with the crank is not possible.



### Sun Screen

Sun shading with ZIP function. When using manual drive, installation on the side with the crank is not possible.



### LED Lighting

4 sided, dimmable lighting (3000K and 900 lm/m). Retrofittable plug-in low-voltage solution (no electrician required). Control set must be ordered separately.

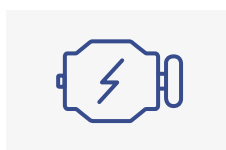

### Electric Motor for Adjusting the Roof Louvres

Retrofittable plug-in low-voltage solution (no electrician required). Control set must be ordered separately.



### Remote + Power Supply Unit

Thanks to the control unit, remote control, power supply unit (max. 320W) and extension lead specially developed for Biohort, the electric motor and/or dimmable LED lighting can be easily retrofitted at any time.



Privacy Screen with Glass Panel  
Metallic Dark Grey

# Privacy Screen

## Decorative Eye-Catcher

### A Piece of Privacy

Our privacy screen not only protects against curious eyes, it also offers protection from wind and direct sunlight. Thanks to the simple plug-in system, the elements can be individually expanded. Regardless of whether it is free-standing or directly on a house wall – the Biohort Privacy Screen is the perfect boundary for your garden oasis.

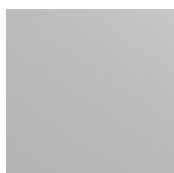

Metallic Silver

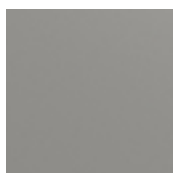

Metallic Quartz Grey



Metallic Dark Grey

10 cm      180 cm      10 cm

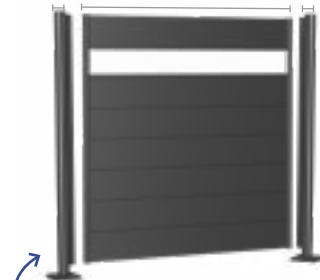

Privacy screen consisting of:  
Wall panels and posts

The posts can be used as end, corner or connecting post between two privacy screen panels.





## Advantages

- Individually configurable
- Extremely durable
- Simple assembly
- Privacy, wind and sun screen
- Screw and rivet free surfaces

## Security:

- High wind resistance due to well-thought-out ground anchoring

## Functionality:

- Free-standing assembly or connection to house wall or similar possible
- Mounting accessories optionally available (see technical details)

Product Info



## Sizes (in cm)

### Posts:

Height adjustable: up to 25 cm  
Diameter: 10 cm

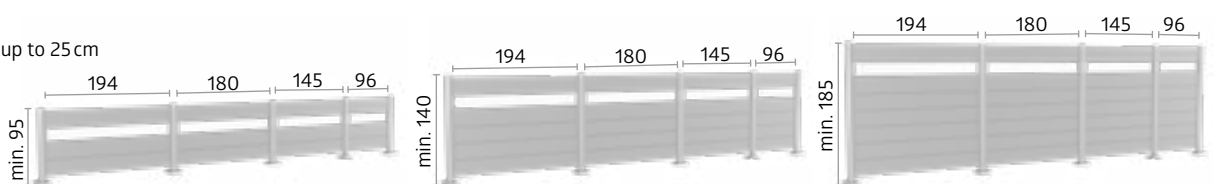

## Optional Accessories

### Components

Wall panels (with or without glass panels) and the appropriate posts are required for a privacy screen.



### Privacy Screen Combinations

The privacy screen can be extended both in a straight line and in different angles.

All widths and heights are compatible with each other, making height gradations also possible.



### Variant 1: Post for anchoring, height-adjustable up to 25 cm

The base plate is bolted to a frost-proof concrete foundation using threaded rod anchors (optional available). Assembly on terrace tiles or wood/WPC boards is not sufficient.

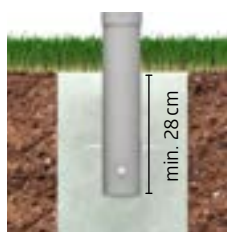

### Variant 2: Post for setting in concrete, height-adjustable up to 25 cm

With this variant, the post is set directly into the concrete foundation.  
Size of foundation points:  
min. 50 x 50 cm (varies depending on soil conditions)  
min. depth: 80 cm (varies depending on privacy screen height)





# A QUESTION OF **STYLE**



**42** Romeo®



**44** StoreMax®



**46** HighBoard



**48** LoungeBox®



**50** StyleBox®



**52** LeisureTime Box



Romeo® Patio Locker Size L<sup>HIGH</sup>,  
Metallic Dark Grey

# Romeo® Patio Locker

## More Space for the Essentials

The Romeo® patio locker creates additional space without needing much space for itself. Moreover, it spoils all balcony and patio fans with an individual shelf range, soft-closing doors due to gas springs and many more details which are typical for Biohort!

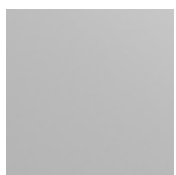

Metallic Silver

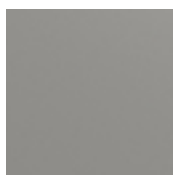

Metallic Quartz Grey



Metallic Dark Grey



Size L, Metallic Dark Grey





## Advantages

- Rainwater proof
- Invisible, integrated ventilation

### Security:

- 2-way locking mechanism with T-handle cylinder lock

### Functionality:

- Comfortable door opening with gas spring

### Standard Equipment:

- Shelves (2 pcs.) and support rails (3 pcs.)
- Organiser system fitted inside the door (incl. 6 hooks)

Product Info



Even more storage space with the new sizes M<sup>HIGH</sup> and L<sup>HIGH</sup>!

## Sizes (in cm, exterior dimensions)

### Door opening:

Size M, Size L: 103 x 131cm (W x H)

Size M<sup>HIGH</sup>, Size L<sup>HIGH</sup>: 103 x 171cm (W x H)

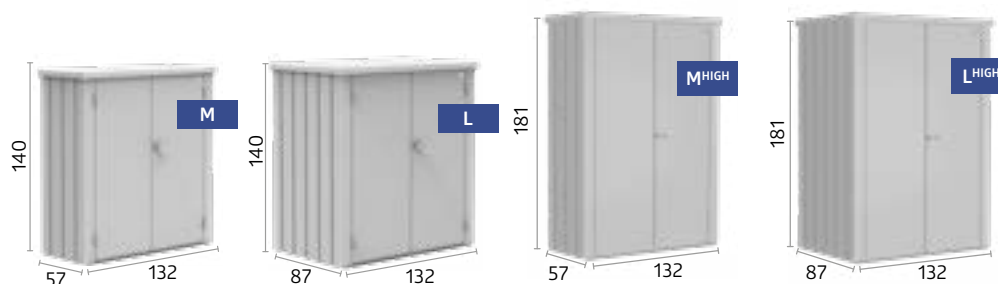

## Optional Accessories



### Shelves (2 pcs.)

Galvanized steel shelves available in addition to the shelves which are part of the standard delivery scope.



StoreMax® Size 120, Metallic Quartz Grey

# StoreMax®

Design Outside,  
Space Inside

## Gardening Joy at the Highest Level

A garden is a feel-good oasis – at least if it is tidy. This is why the StoreMax® offers maximum storage space in a small space, which can be individually divided up with shelves and shelving units. Whether as a lawn mower garage, garden tool box or storage space for pillows, behind the two-part opening system there is room for everything!



Metallic Silver



Metallic Quartz Grey

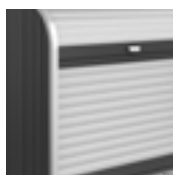

Metallic Dark Grey



The top shutter can be opened separately.



To fully open the StoreMax® the front shutter fully glides back.





## Advantages

- Rainwater proof
- Shutter made from aluminium

### Security:

- 2-way locking mechanism with T-handle cylinder lock

### Functionality:

- Easy operation due to spring support

### Standard Equipment:

- Tool holder on the inside of the side wall

Product Info



## Sizes (in cm)

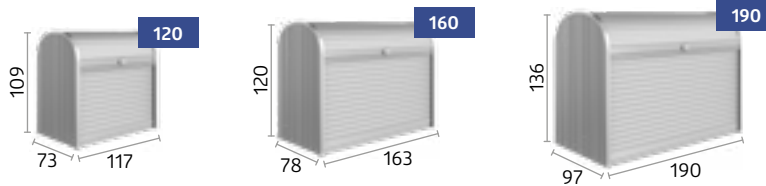

## ★ Optional Accessories



### Corner Shelf Set (suitable for size 120 & 160)

2 shelves (triangular-shaped) with support rails, height adjustable in 5 different positions, easy to retrofit without any tools, can be fitted on the left or the right as required.



### Shelf Set (suitable for size 190)

2 steel shelves (72 x 24,5 cm) and 2 support rails.



### Intermediate Floor (suitable for size 160 & 190)

2-pieces, galvanised steel shelf with support rails, supports a load of ca. 100 kg; can also be used as a 2-piece shelf, height adjustable in 5 different positions, easy to retrofit.





**HighBoard Size 160, Metallic Dark Grey**  
 (with tool holder and intermediate floor as accessories)

# HighBoard

## Highlight on the Patio

### Multitalent for Storage

Thanks to the double doors and opening lid, the applications for the HighBoard are almost limitless: whether as a storage space for cushions and garden equipment or as the perfect extension to your outdoor kitchen, everything is protected from the weather and neatly stowed away. Its elegant design has been developed by industrial designers and is a guaranteed highlight on every patio.



Metallic Silver



Metallic Quartz Grey

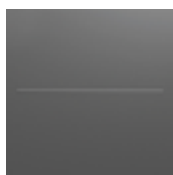

Metallic Dark Grey



**Size 160, Metallic Quartz Grey with Intermediate Floor**



### Advantages

- Rainwater proof
- Invisible, integrated ventilation
- Screw and rivet free surfaces

**Security:**

- Locking mechanism with turn knob cylinder lock

**Functionality:**

- Comfortable lid opening with gas spring
- The lid can also be opened easily when placed directly against a wall

**Standard Equipment:**

- Wheelie bin lid opener (3 pcs.)



### Sizes (in cm)

#### Door opening:

Size 160: 140 x 100 cm (W x H)  
Size 200: 167 x 110 cm (W x H)

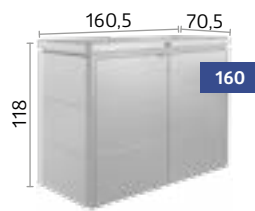

### Optional Accessories



#### Suspension Basket

The sack made of black polyester mesh offers additional variable storage space and is simply hooked onto the frame. Load capacity max. 10 kg.



#### Tool Holder

For mounting on the inside of the doors. Max. 2 tool holders per door panel possible.



#### Intermediate Floor

In metallic silver, 9 position height adjustment. Easy to install and universally adaptable (e.g. as a continuous shelf or as 2 shelves). Load capacity max. 50 kg.



#### Lid Storage Net

The solution for small objects. It can be easily attached to the inside of the lid.



LoungeBox® Size 160, Metallic Dark Grey

# LoungeBox®

Stylish Elegance

## Design for High Standards

The LoungeBox® is the perfect storage solution for seat cushions and many other things for which one can never find a suitable place. Due to its appealing look, it blends in well on every patio.



Metallic Silver



Metallic Quartz Grey

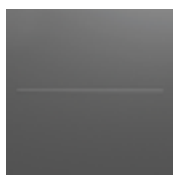

Metallic Dark Grey



Size 160, Metallic Dark Grey





## Advantages

- Rainwater proof
- Invisible, integrated ventilation
- Lid made from aluminium
- Screw and rivet free surfaces

### Security:

- Locking mechanism with turn knob cylinder lock
- The lid can also be opened easily when placed directly against a wall

### Functionality:

- Comfortable lid with gas spring

Product Info



## Sizes (in cm)

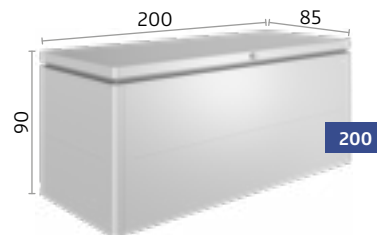
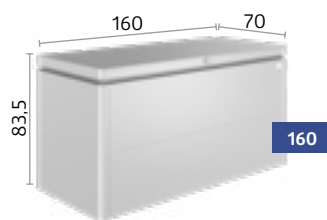

## ★ Optional Accessories



### Suspension Basket

The sack made of black polyester mesh offers additional variable storage space and is simply hooked onto the frame. Load capacity max. 10 kg.



### Lid Storage Net

The solution for small objects. It can be easily attached to the inside of the lid.



StyleBox® Size 170, Metallic Dark Grey

# StyleBox®

For More Lifestyle

## Storage as a Design Element

The outdoor box has a high-quality and stylish appearance thanks to its smooth surfaces and flawless finish. The innovative push-fit system allows installation in less than 20 minutes. Whether on the terrace, the balcony or in the garden – the design fits perfectly into any environment.

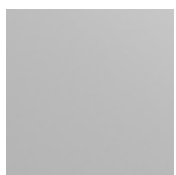

Metallic Silver

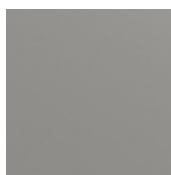

Metallic Quartz Grey

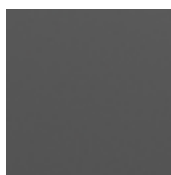

Metallic Dark Grey



Size 170, Metallic Quartz Grey  
with suspension basket and lid storage net



### Advantages

- Rainwater proof
- Invisible, integrated ventilation
- Elegant design with smooth surfaces
- Quick assembly in under 20 minutes thanks to innovative push-fit system

**Security:**

- Lockable by means of cable padlock (lock not included)

**Functionality:**

- Comfortable lid with gas spring
- Practical snap lock

**Standard Equipment:**

- Four height adjustable feet for levelling on uneven floors



OUTDOOR BOXES

### Sizes (in cm)

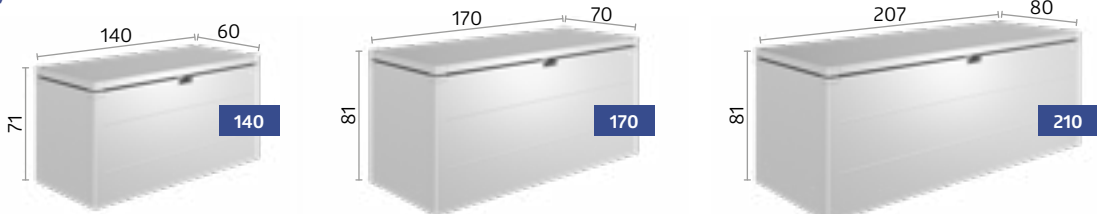

### ★ Optional Accessories



**Suspension Basket**  
 The sack made of black polyester mesh offers additional variable storage space and is simply hooked onto the frame. Load capacity max. 10 kg.



**Castors**  
 Two rubberised, rigid castors are mounted on one side to enable the box to be moved. 2 pieces per package.



**Lid Storage Net**  
 The solution for small objects. It can be easily attached to the inside of the lid.





LeisureTime Box Size 160<sup>HIGH</sup>, Metallic Quartz Grey

# LeisureTime Box

Stylish & Durable

## The Perfect Box for Outside

It stores all those items you cannot find a suitable storage place for. Ideal for stowing away seat cushions, toys, sun loungers, folding chairs, sports and camping equipment. 5 sizes, 5 colours for every demand. The perfect long-lasting solution through the use of high-quality materials.

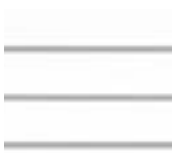

White



Metallic  
Silver



Metallic Quartz  
Grey

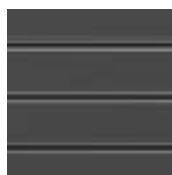

Metallic Dark  
Grey



Metallic  
Bronze



### Advantages

- Rainwater proof
- Invisible, integrated ventilation

**Security:**

- 2-way locking mechanism with T-handle cylinder lock

**Functionality:**

- Comfortable lid with gas spring



OUTDOOR BOXES

### Sizes (in cm)

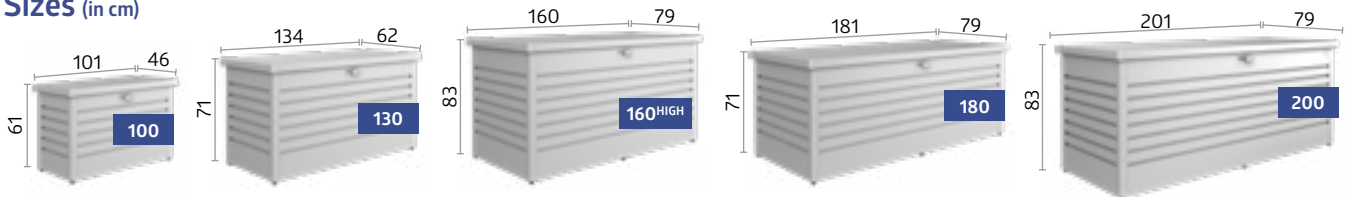

Tip: Also ideal as Parcel Box!

### Optional Accessories



#### Suspension Basket

The sack made of black polyester mesh offers additional variable storage space and is simply hooked onto the frame. Load capacity max. 10 kg.



#### Lid Storage Net

The solution for small parts can be easily attached to the inside of the lid. Two nets can be fixed side by side in the LeisureTime Box 180.



#### Parcel Box Kit

Stainless steel locking bar and padlock with number combination and stainless steel securing cable.









# FOR THE LOVE OF BICYCLE



**56** MiniGarage



**58** StoreMax®



**60** HighBoard

**TIP:** Biohort garden sheds also offer enough space to store bicycles safely. Details on page 8.



**MiniGarage L Metallic Dark Grey**  
 (with aluminium floor frame, aluminium floor panels, bike rails,  
 electrical mounting panel and shelf set as accessories)

# MiniGarage

Small with Big Benefits

## Secure Bicycle Garage with Practical Details

The MiniGarage is ideal for storing up to two bicycles or garden tools and garden furniture etc. The intelligent rail system (optional) facilitates the storage of bicycles: Place the front wheel in the guide rail, push it to the back with the bicycle seat until the front wheel is in the clamp, done! The shelf set is ideal for storing additional bicycle accessories.

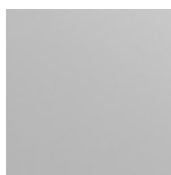

Metallic Silver

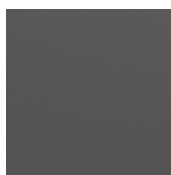

Metallic Dark Grey



**Size L, Metallic Dark Grey**  
 with bicycle rail, electrical mounting panel  
 and shelf set



### Advantages

- Rainwater proof
- Invisible, integrated ventilation

**Security:**

- Locking mechanism with turn T-handle cylinder lock

**Functionality:**

- Comfortable door opening with gas spring

**Standard Equipment:**

- Organiser system fitted inside the door (incl. 6 hooks)



BICYCLE STORAGE

### Sizes (in cm)

**Door opening:**  
125 x 137 cm (W x H)

**Interior dimensions:**  
140 x 195 x 143 cm (L x W x H)

**Storage capacity:**  
2 adult bicycles (please check the dimensions of your bicycles, see [www.biohort.com](http://www.biohort.com) for more information)

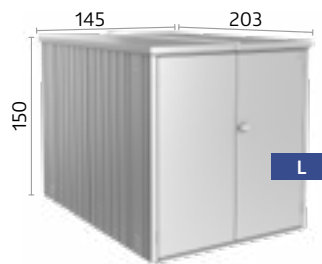

### ★ Optional Accessories



#### Bike Rail

The clamp panel is mounted on the back wall. The guide rail is hooked in at the desired height and allows for easy extraction and storage of bikes. Max. 2 bike rails possible. Max. Tyre width: 70 mm, max. bike length: 1,92 m;



#### Shelf Set

2 shelves (77 x 26,8 cm) and 2 support rails.



#### Electric Mounting Panel

Discreet, hidden cable routing and easy assembly of switches and outlets (electrical equipment in photo not included). Incl. 2 support rails.



#### Foundation Solutions

Aluminium Floor Frame/ Aluminium Floor Panels SmartBase / SmartBase<sup>PLUS</sup>

For details, see page 28 – 31.





StoreMax® Size 190, Metallic Silver

# StoreMax®

## Roller Shutter Up, Bicycle Out

### Cuts Quite a Figure

Right in front of your home, immediately ready: the rainproof StoreMax® bicycle garage with the BikeHolder offers a maximum of storage without needing much space itself – perfect dimensions for up to two bicycles. The very smoothly working roller shutter helps you save your energy for the bicycle tour and protects your bicycle with a robust cylinder lock.



Metallic Silver



Metallic Quartz Grey



Metallic Dark Grey



The top shutter can be opened separately.



To fully open the StoreMax® the front shutter fully glides back.



## Advantages

- Rainwater proof
- Shutter made from aluminium

### Security:

- 2-way locking mechanism with T-handle cylinder lock

### Functionality:

- Easy operation due to spring support

### Standard Equipment:

- Tool holder on the inside of the side wall

Product Info



## Size (in cm)

### Interior dimensions:

188 x 86 cm (W x H)

### Storage capacity:

2 adult bicycles (please check the dimensions of your bicycles, see [www.biohort.com](http://www.biohort.com) for more information)

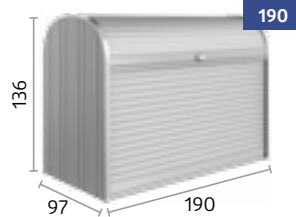

## ★ Optional Accessories



### BikeHolder Set

The base plate including adjustable clamping levers can be hooked into 2 shelf support rails and provides optimal storage for 2 bicycles.







HighBoard Size 200, Metallic Quartz Grey  
(with BikeHolder as accessory)

# HighBoard

A Roomy Home for  
Your Bicycle

## Store Your Valuables Safely

Cycling keeps you fit and the HighBoard keeps your bicycle running: absolutely rainwater proof, with integrated ventilation, special bicycle holders and a robust cylinder lock to protect it from theft. Up to two bicycles can be easily stowed and removed due to the lid which can be additionally opened. So nothing is standing in the way of a spontaneous cycling tour.



Metallic Silver



Metallic Quartz Grey

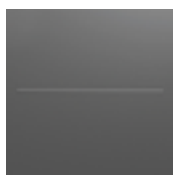

Metallic Dark Grey



Size 200, Metallic Silver with BikeHolder





## Advantages

- Rainwater proof
- Invisible, integrated ventilation
- Screw and rivet free surfaces

### Security:

- Locking mechanism with turn knob cylinder lock

### Functionality:

- Comfortable lid opening with gas spring
- The lid can also be opened easily when placed directly against a wall

### Standard Equipment:

- Wheelie bin lid opener (3 pcs.)

Product Info



## Size (in cm)

**Door opening:**  
167 x 110 cm (W x H)

**Interior dimensions:**  
195 x 76 x 120 cm (L x W x H)

**Storage capacity:**  
2 adult bicycles (please check the dimensions of your bicycles, see [www.biohort.com](http://www.biohort.com) for more information)

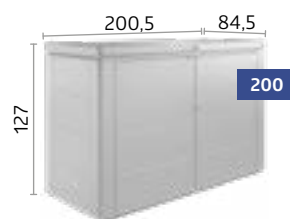

## ★ Optional Accessories



### BikeHolder

The base plate including adjustable clamping levers can be hooked onto the inside of the side wall and provides optimal storage for 2 bicycles.



### Electric Mounting Panel

Discreet, hidden cable routing and easy assembly of switches and outlets (electrical equipment in photo not included).



### Tool Holder

For mounting on the inside of the doors. Max. 2 tool holders per door panel possible.



### Lid Storage Net

The solution for small objects. It can be easily attached to the inside of the lid.

A modern, light-colored recycling bin with a green lid and a black lid, set against a backdrop of a green landscape and mountains. The bin is open, revealing a green recycling bin inside. The background shows a lush green landscape with a white fence and a mountain range in the distance.

# THE MOST APPEALING WAY TO SEPARATE WASTE



**64** Alex®



**66** Alex® Duo



**68** StoreMax®



**70** HighBoard





Alex®, Metallic Quartz Grey

# Alex® Modular Wheelie Bin Box

## Modern Design, Clever Details

With the new Alex® wheelie bin system, any number of boxes can be arranged in a row, even at a later date, and thus separation systems can be optimally accommodated. The wheelie bin can be easily tipped out, the retaining bracket fixes it in the inclined position and facilitates filling. With its modern design, Alex® cuts a fine figure in every driveway!



Metallic Silver



Metallic Quartz Grey

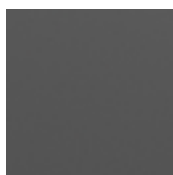

Metallic Dark Grey



Two Combined Alex® Wheelie Bin Boxes, Metallic Quartz Grey

Function floor for wheel positioning



### Advantages

- Can be expanded as required due to modular design
- Integrated ventilation
- Stable roof for planters
- Rainwater proof

**Security:**

- Locking mechanism with turn knob cylinder lock

**Standard Equipment:**

- Catch bar for tipping out the wheelie bin
- Function floor for wheel positioning
- Hooks on the inside of the door (6 pcs.)



### Size (in cm)

#### Door opening:

65 x 118 cm (W x H)  
Available with left door hinge

#### Storage capacity:

120 L wheelie bin or  
240 L wheelie bin

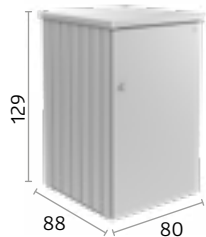

## ★ Optional Accessories

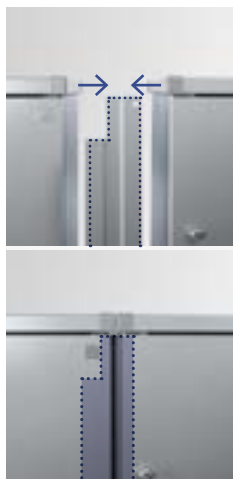

### Connecting Element

The connecting element covers the gap between two wheelie bin boxes at the front and back.



### Matching Cylinder Lock

If several boxes are used, access is possible with only one single key.



### Shelves / Supports Rails (2 pcs.)

Galvanised steel shelves (72 x 24,5 cm) are suspended in the support rails.  
Max. 4 shelves per wheelie bin box possible.



Alex® Duo, Metallic Quartz Grey  
(with floor kit as accessory)

# Alex® Duo

## Double Wheelie Bin Box

### Design Meets Practicality

Nothing spoils the image of a perfectly manicured front garden more than visible wheelie bins. Thanks to Biohort, these can be concealed behind a modern, smooth front. With the new Alex® Duo, the separation system is optimally accommodated, tidiness is emphasised and an attractive overall appearance is created in the garden.

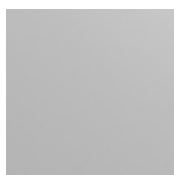

Metallic Silver

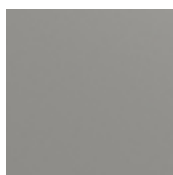

Metallic Quartz Grey

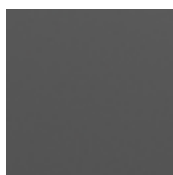

Metallic Dark Grey

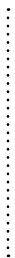

Alex® Duo Double Wheelie Bin Box,  
Metallic Quartz Grey

Catch bar for tipping out the wheelie bin





### Advantages

- Integrated ventilation
- Rainwater proof

**Security:**

- 2-way locking mechanism with T-handle cylinder lock

**Standard Equipment:**

- Comfortable door opening with gas spring
- Catch bar for tipping out the wheelie bin
- Plug-in ground rail for positioning the wheelie bin wheels
- Hooks on the inside of the door (6 pcs.)



### Sizes (in cm)

**Door opening:**  
129 x 118 cm (W x H)

**Storage capacity:**  
1 x 120 L wheelie bin  
1 x 240 L wheelie bin  
2 x 120 L wheelie bins  
2 x 240 L wheelie bins

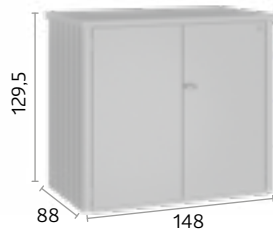

Now you can also store **2 x 240 L** wheelie bins neatly!

### Optional Accessories



**Floor Kit**  
Aluminium floor frame, aluminium floor panels and threshold access ramp.  
The aluminium floor panels serve as a functional floor and is underlaid with XPS hard foam boards (not included in delivery).



**Shelves / Supports Rails (2 pcs.)**  
Shelf are suspended in the support rails.



StoreMax® Size 160, Metallic Dark Grey

# StoreMax®

## Designer Cover for the Wheelie Bins

### Elegant Functionality

Up to three 240 L wheelie bins can be hidden behind the easily gliding roller shutters. The two-part opening system with its separately opening roller shutter allows for comfortable access to the hidden bins – and the easy removal of the wheelie bins when it is completely open.



Metallic Silver



Metallic Quartz Grey



Metallic Dark Grey



The top shutter can be opened separately.



To fully open the StoreMax® the front shutter fully glides back.





**Advantages**

- Rainwater proof
- Shutter made from aluminium

**Security:**

- 2-way locking mechanism with T-handle cylinder lock

**Functionality:**

- Easy operation due to spring support

**Standard Equipment:**

- Tool holder on the inside of the side wall



### Sizes (in cm)

#### Storage capacity:

Size 120: 2 x 120 L wheelie bins

Size 160: 3 x 120 L wheelie bins or 2 x 240 L wheelie bins (transverse)

Size 190: 3 x 120 L wheelie bins or 3 x 240 L wheelie bins

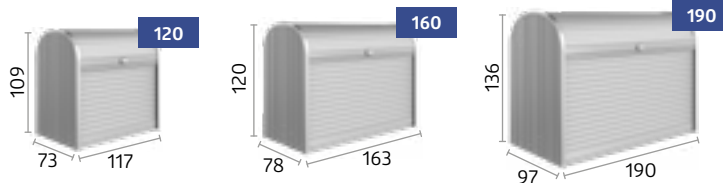

### ★ Optional Accessories



#### Corner Shelf Set (suitable for size 120 & 160)

2 shelves (triangular-shaped) with support rails, height adjustable in 5 different positions, easy to retrofit without any tools, can be fitted on the left or the right as required.







HighBoard Size 200, Metallic Silver

# HighBoard

Something Nobel in the Front Garden

## The Unsightly Beautifully Stowed

Wheelie bins are not easy on the eye – unless they are hidden in noble industrial design. Additionally, the HighBoard allows for easy filling and emptying of the bins with its spacious doors and the additional lid opening. And the robust cylinder lock prevents foreign waste from being deposited.

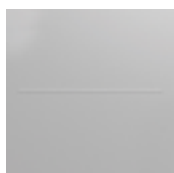

Metallic Silver



Metallic Quartz Grey



Metallic Dark Grey



Size 200, Metallic Quartz Grey



### Advantages

- Rainwater proof
- Invisible, integrated ventilation
- Screw and rivet free surfaces

**Security:**

- Locking mechanism with turn knob cylinder lock

**Functionality:**

- Comfortable lid opening with gas spring
- The lid can also be opened easily when placed directly against a wall

**Standard Equipment:**

- Wheelie bin lid opener (3 pcs.)



### Sizes (in cm)

**Door opening:**

Size 160: 140 x 100 cm (W x H)  
Size 200: 167 x 110 cm (W x H)

**Storage capacity:**

Size 160: 3 x 120 L wheelie bins  
Size 200: 3 x 120 L wheelie bins or 3 x 240 L wheelie bins

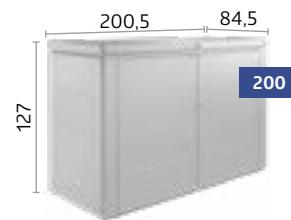
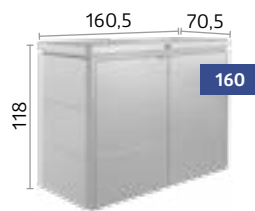

### ★ Optional Accessories



**Tool Holder**

For mounting on the inside of the doors. Max. 2 tool holders per door panel possible.



THIS IS WHERE  
**I THRIVE**





**74** Raised Bed



**76** Belvedere®



**80** DaVinci®



Raised Bed 2x1, Metallic Silver

# Raised Bed

## Clever Cultivation

### The Best Conditions for a Bountiful Harvest

Raised beds make cultivation easier and maximise the harvest – but only the Biohort raised bed perfects the most beautiful hobby in the world with intelligent design and practical functionality. Thanks to the optional intermediate floor, you need less potting soil. Ingenious details add to the eye catching effect of this product, which offers more than just beauty!

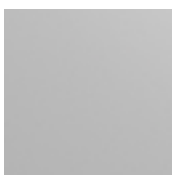

Metallic Silver

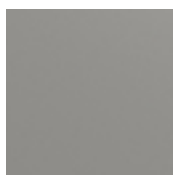

Metallic Quartz Grey



Metallic Dark Grey



Size 2x1, Metallic Dark Grey with Cold Frame Extension in Metallic Quartz Grey





## Advantages

- Extremely durable
- Quickly assembled – only 8 screws
- Optimum working height
- Screw and rivet free surfaces

### Security:

- Integrated rodent protection made of fibreglass fabric

### Functionality:

- Cold frame extension, intermediate floor, slug guard, trellis, skirting
- Sliding side walls make it easy to empty
- Opening for irrigation hose
- An ideal place to recycle garden cuttings

Product Info



## Sizes (in cm)

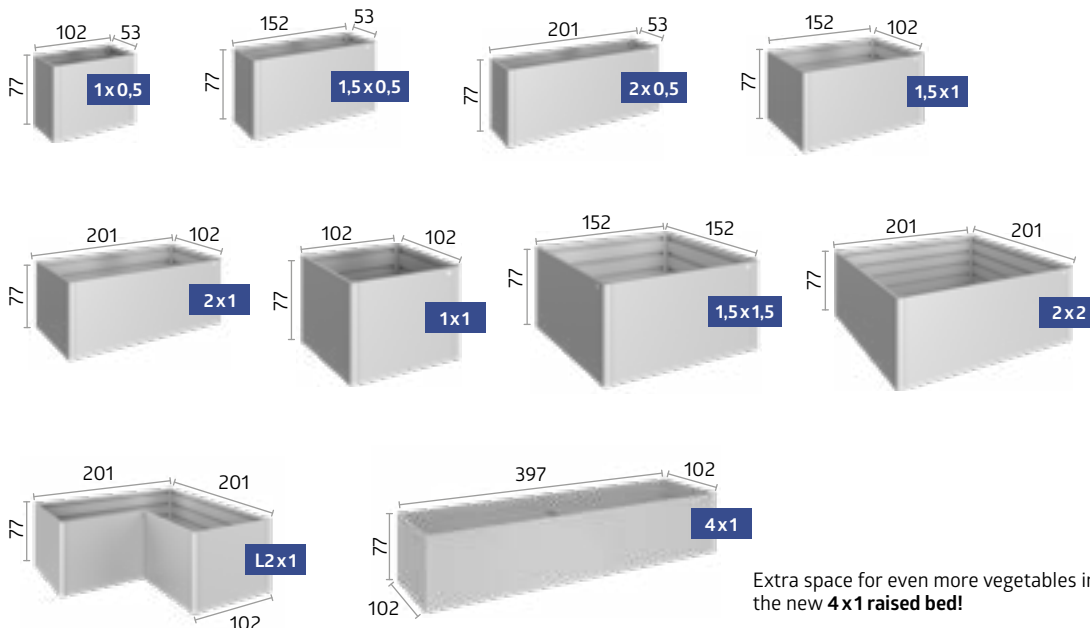

Extra space for even more vegetables in the new **4x1 raised bed!**

★ **Optional Accessories Available on Pages 78 – 79.**





Belvedere® L150<sup>MAXI</sup>, Metallic Quartz Grey

# Belvedere®

Experiencing Design

## The Eye-Catcher for Your Terrace

With a width of only 50 cm, the Belvedere® planting bed creates a space for special ideas: as a living, plant filled room divider, it adds structure to your patio or garden and also embellishes your balcony. This gives you completely new design options and you can also save on potting soil with the standard intermediate floor.



Metallic Silver



Metallic Quartz Grey

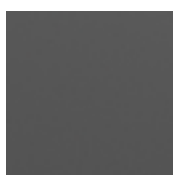

Metallic Dark Grey



Size L100, Metallic Silver with Trellis



### Advantages

- Extremely durable
- Quickly assembled
- Screw and rivet free surfaces

**Security:**

- Integrated rodent protection made of fibreglass fabric

**Functionality:**

- Skirting, trellis, privacy screen and planting insert optionally available
- Opening for irrigation hose

**Standard Equipment:**

- Intermediate floor



### Sizes (in cm)

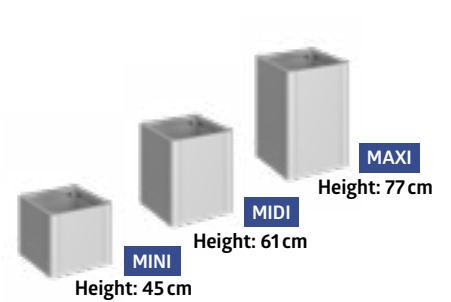
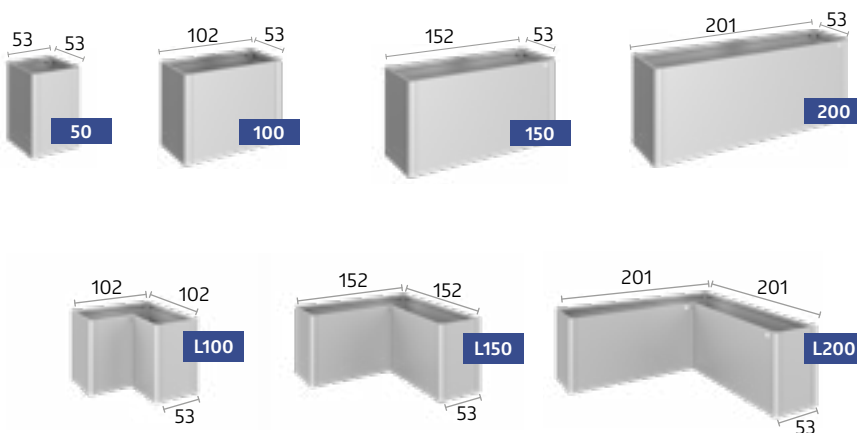

**Tip:** All sizes are available in three different heights!

★ **Optional Accessories Available on Pages 78 – 79.**

✓ **Standard Equipment**

★ **Optional Accessories**

		Raised Bed	Belvedere®
01	<b>Sliding Panel*</b> Easy to empty thanks to sliding panel.	✓	
02	<b>Preparation for Irrigation</b> Opening for watering hose on the narrow side (size: 17 x 17 mm).	✓	✓
03	<b>Rodent Protection</b> Integrated rodent protection made of fibreglass fabric. Is inserted before filling.	✓	✓
04	<b>Intermediate Floor*</b> The intermediate floor reduces the volume of the bed and the soil filling required, saving both money and valuable time. It is placed on the second corrugation during assembly.	★	✓
05	<b>Cold Frame Extension*</b> Efficient frost protection with 4 easily removable sliding panels. The cold frame extension is storm-proof and designed to direct rainwater into the raised bed. Cannot be combined with Trellis (09). Only suitable for size 2x1.	★	
06	<b>Slug Guard*</b> It is placed on top of the raised bed. Can be combined with a cold frame extension (05). Not available for L-sizes and raised bed 4x1.	★	★
07	<b>Skirting*</b> The skirting is mounted on the floor frame and placed on the lawn. The raised bed is then placed on the skirting and fastened (cannot be installed afterwards). Width: 6.7 cm. Not available for raised bed 4x1.	★	★
08	<b>Planter Insert</b> Plastic insert (size: 0,5 x 0,5 m) for easier planting, is placed on the intermediate floor. Holes for drainage can be drilled without any problems.		★
09	<b>Trellis*</b> The trellis is attached directly to the raised/planting bed. Cannot be combined with cold frame extension (05) or slug guard (06). Height: 91 cm	★	★
10	<b>Privacy Screen* with or without Tinted Glass Panel</b> In conjunction with the planting bed, the privacy screen forms a decorative boundary and serves not only as a privacy but also as a windscreen. Cannot be combined with cold frame extension (05) or slug guard (06). Height: 91 cm.  Note: In places exposed to the wind, the product with privacy screen is at high risk of tipping, so it is essential to ensure that it is adequately fixed to the ground using the fixing materials supplied.	★	★

\*Made from galvanised, polyamide coated steel





01 Sliding Panel



02 Preparation for Irrigation



03 Rodent Protection



04 Intermediate Floor



05 Cold Frame Extension



06 Slug Guard



07 Skirting



08 Planter Insert



09 Trellis



10 Privacy Screen with or without Tinted Glass Panel

Are you looking for an individual solution?

**DaVinci®**

Planter Box System





**DaVinci®, Metallic Quartz Grey**  
 Combination of different heights, lengths, with privacy screen and trellis

# DaVinci®

## Flexible Planter Box System

### Limitless Individuality

Design the flexible DaVinci® planter box system as you wish. From planting bed with height graduations to privacy screen and terrace borders, there are no limits to the possibilities. The basic modules in different versions can be individually combined. With the help of the 3D-Configurator, your DaVinci® planter box system can be visualized with just a few clicks.

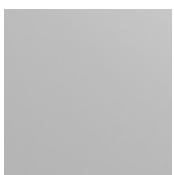

Metallic Silver



Metallic Quartz Grey

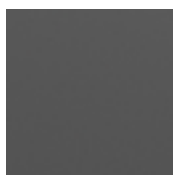

Metallic Dark Grey



**DaVinci® as Flower Bed**  
 Combination of different heights and lengths.





**Advantages**

- Individually configurable
- Extremely durable
- Available in different lengths, heights and combinations
- Screw and rivet free surfaces

**Functionality:**

- Privacy screen and trellis can be placed as desired
- Ideal as a terrace border

**Standard Equipment:**

- Intermediate floor



### 3 Heights, 4 Lengths, 3 Colours and Countless Possibilities

Possible heights from 45 cm to 77 cm and lengths from 50 cm to 200 cm

Thanks to the modular construction, there are no limits to your wishes. The basic modules can be arranged in any order. Privacy screen and trellis can be positioned freely according to your expectations.

Configure your own DaVinci® planter box system now!  
[www.biohort.com/configurator](http://www.biohort.com/configurator)

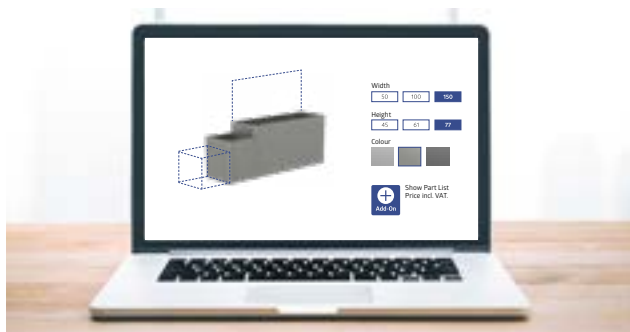

Configure your own DaVinci® planter box system now!  
[biohort.com/configurator](http://biohort.com/configurator) or QR code above.

### Flexible, Convenient and Versatile Configurations



**DaVinci® as Privacy Screen**  
Combination of different heights, lengths and two privacy screens.

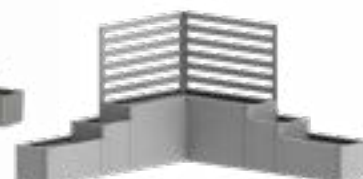

**DaVinci® as Terrace Border**  
Combination of different heights, lengths and two trellises.





EVERYTHING FOR  
THE **OUTDOOR**  
**OASIS**



**84** MonAmi®



**85** Charly®



**86** WoodStock®



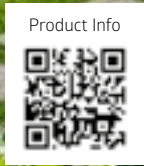

MonAmi®, Metallic Dark Grey

# MonAmi® Composter

As "my friend" in the garden, the MonAmi® composter combines functionality with stylish appearance: elegant, smooth surfaces on the outside, inside everything required for efficient composting. Two centrally placed ventilation pipes create a chimney effect and ensure a reliable circulation of air, meanwhile the circumferential gap underneath the cover ensures that heat is transferred out of the composter. Even composting can now look great!

### Advantages

- Extremely durable
- Screw and rivet free surfaces

### Functionality:

- Integrated rodent protection made of fibreglass fabric

### Standard Equipment:

- Ventilation system ensures an optimal rotting process
- Sliding front wall panel makes it convenient and easy to empty
- Comfortable lid with gas spring

### Size (in cm)

Volume:

725 l

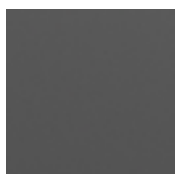
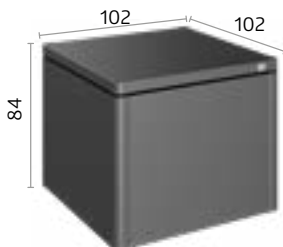

Metallic Dark Grey

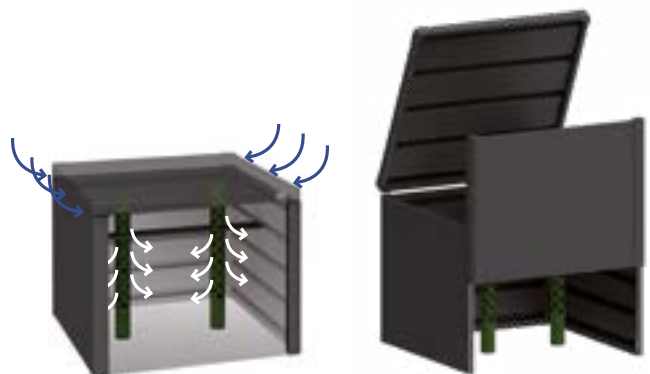

### Ventilation Pipes

The integrated ventilation pipes provide an optimal supply of oxygen and circulation of air, which is essential for efficient composting.

### Sliding Panel

Sliding front wall panel makes it convenient and easy to empty.





Charly® Size 2

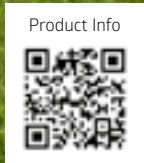

# Charly®

## Robotic Lawn Mower Garage

A shelter from the rain is not only the least that your hard-working robotic lawn mower deserves, but is also highly recommended for the protection of your robot! Suitable for many commercially available models, Charly® robot garage offers all the convenience that robots and owners need. The folding lid offers easy access to the control panel.

### Size (in cm)

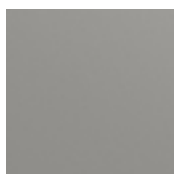
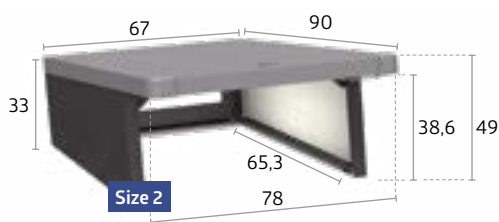

Lid:  
Metallic Quartz  
Grey



Side Walls:  
Metallic Dark  
Grey

### Advantages

#### Security:

- Folding-locking mechanism
- Corner protectors
- Ground screw fasteners

#### Functionality:

- Easy access to the control panel due to folding lid

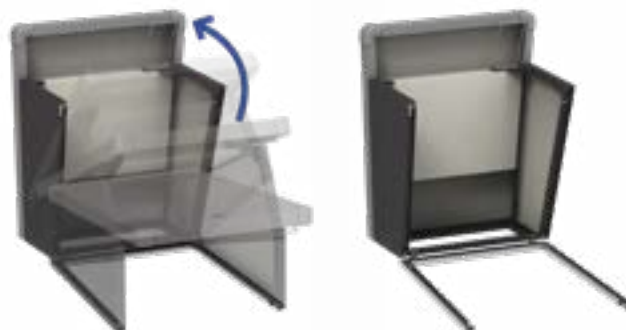

#### Folding-locking mechanism

The folding lid with its locking mechanism offers easy access to the control panel.



WoodStock® Size 230, Metallic Dark Grey

# WoodStock®

All-rounder

## Firewood Storage and Equipment Locker in One

Nothing conjures up a cosier atmosphere than a blazing fire burning in the chimney on a cold winters day. But where to store the firewood? The WoodStock® provides the tidy and lasting solution for this question. During the summer it offers plenty of space for garden furniture and equipment. The possibility of attaching it to the house wall has proven to be particularly practical.



Metallic Silver



Metallic Quartz Grey



Metallic Dark Grey



WoodStock® Size 300, Metallic Quartz Grey





### Advantages

- Stability because of massive aluminium frame

**Security:**

- Integrated gutter on the front side
- Universally applicable for garden tools
- Wide range of accessories available

**Functionality:**

- Screws and anchors for fixation to the ground



### Sizes (in cm)

**Volume:**

Size 150: 2.1m<sup>3</sup>

Size 230: 3.1m<sup>3</sup>

Size 300: 4 m<sup>3</sup>

Possible to store wood in two rows  
(max length of firewood: 35 cm)

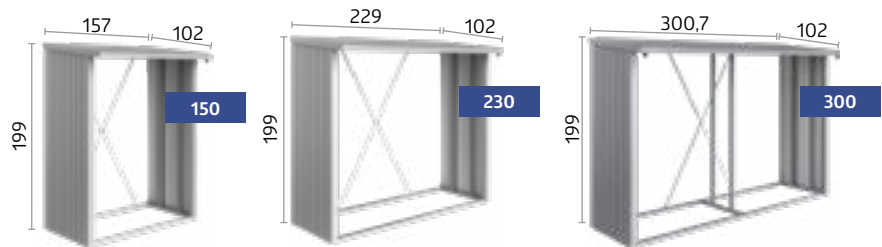

### ★ Optional Accessories



**Aluminium Floor Panels**

High quality aluminium chequer plate, protects the stored wood and gardening equipment from moisture.



**Door Package**

(suitable for size 150 & 230)

Double door fitted with T-handle cylinder lock and organiser system on the inside of the doors. Door opening: 135 x 171 cm (W x H).



**Back Wall**

Made from galvanised, polyamide coated steel.



# Why Metal:

- + No Painting
- + The high-quality steel used by Biohort does not deform and remains in shape for decades.
- + The hot-dip galvanised, polyamide enamel coated steel used by Biohort is "fireproof" in accordance with EN 13501-1 (Class "A1")
- + Even premium German car manufacturers trust the same steel as we do.

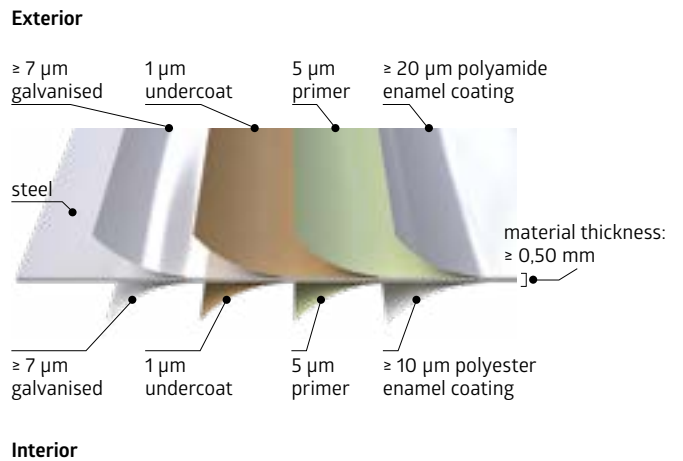

# Did You Know?



## Stability Test

A scientifically supervised test in the wind tunnel of the Vienna University of Technology certifies that Biohort garden sheds can withstand wind loads of up to 150 km/h (wind force 12) when properly assembled and anchored. Optimally designed profiles and the use of stainless steel screws further contribute to the durability of our products.



## Material

Biohort uses **galvanised steel** with an additional **stove-enamel** finish with polyamide for its products. The use of top-quality materials ensures that Biohort can confidently offer a **20 year guarantee** against corrosion. The prerequisite for this is that no aggressive substances (e.g. chlorine, salt, etc.) are stored and that there are no aggressive environmental conditions such as proximity to the sea or exposure to road salt.



## Biohort Colours

The colour coatings we use are produced exclusively for Biohort and do not match the **RAL numbers**. Since many Biohort dealers have show models or original colour samples, we recommend visiting them before your purchase. Furthermore, you can request free material samples (colour sample sheets) on our website!



The General Terms and Conditions (GTC) of Biohort GmbH apply. You can find these at: [biohort.com/agb](http://biohort.com/agb)  
 Our terms of guarantee are available here: [www.biohort.com/terms-of-guarantee](http://www.biohort.com/terms-of-guarantee)

# Sustainability is Our Claim

As an Austrian family business, we have been focusing on uncompromising sustainability for over 30 years. We are aware of our responsibility and always act according to the credo: **Today's actions have a decisive impact on tomorrow – economically, ecologically and socially!**

## To Love the Environment

We focus on sustainable and environmentally friendly production. Biohort products have a very **long service life** and the processed steel plate is 100% recyclable. Short delivery and transport distances ensure low CO<sub>2</sub> emissions and our **packaging** is almost completely made of recyclable material. 100% of internal transport is carried out with **electric vehicles**.

All our company buildings are equipped with **photovoltaic systems**. With the solar power we produce ourselves, we cover one third of the annual electricity requirements of our production.

We currently cover 10% of the heating energy requirements of our company buildings with **heat pumps** and, in future, an additional 50% with **biomass heating** from our waste wood. In total, almost half of our total energy requirements can be met from our own, sustainable sources.



Steel is 100%  
Recyclable



Local Suppliers



Production in  
Austria







Sustainable  
Energy Sources



Supporting  
Sustainable  
Forestry

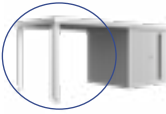
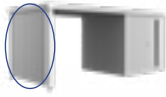

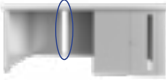



# Neo Garden Shed

Neo	Size	Exterior Dimensions*	Interior Dimensions	Foundation Dimensions	Weight	EAN Code		
		W x L x H (cm)	W x L x H (cm)	W x L (cm)	(kg)	Metallic Silver	Metallic Quartz Grey	Metallic Dark Grey
With standard door, door opening: 83 x 200 cm (W x H), right door hinge								
	1A	180 x 180 x 222	164 x 164 x 208	173 x 173	211,5	9003414 81003 7	9003414 87003 1	9003414 85003 3
	2A	180 x 236 x 222	164 x 220 x 208	173 x 229	243,7	9003414 81006 8	9003414 87006 2	9003414 85006 4
	3A	180 x 292 x 222	164 x 276 x 208	173 x 285	304,4	9003414 81009 9	9003414 87009 3	9003414 85009 5
	4A	180 x 348 x 222	164 x 332 x 208	173 x 341	335,8	9003414 81014 3	9003414 87014 7	9003414 85014 9
	1B	236 x 180 x 222	220 x 164 x 208	229 x 173	245,9	9003414 81029 7	9003414 87029 1	9003414 85029 3
	2B	236 x 236 x 222	220 x 220 x 208	229 x 229	284,7	9003414 81034 1	9003414 87034 5	9003414 85034 7
	3B	236 x 292 x 222	220 x 276 x 208	229 x 285	349,2	9003414 81040 2	9003414 87040 6	9003414 85040 8
	4B	236 x 348 x 222	220 x 332 x 208	229 x 341	392,9	9003414 81044 0	9003414 87044 4	9003414 85044 6
	1C	292 x 180 x 222	276 x 164 x 208	285 x 173	311,9	9003414 81082 2	9003414 87082 6	9003414 85082 8
	2C	292 x 236 x 222	276 x 220 x 208	285 x 229	348,7	9003414 81085 3	9003414 87085 7	9003414 85085 9
	3C	292 x 292 x 222	276 x 276 x 208	285 x 285	433,9	9003414 81089 1	9003414 87089 5	9003414 85089 7
	4C	292 x 348 x 222	276 x 332 x 208	285 x 341	474,7	9003414 81092 1	9003414 87092 5	9003414 85092 7
	1D	348 x 180 x 222	332 x 164 x 208	341 x 173	340,1	9003414 82024 1	9003414 89024 4	9003414 86024 7
	2D	348 x 236 x 222	332 x 220 x 208	341 x 229	383,5	9003414 82028 9	9003414 89028 2	9003414 86028 5
	3D	348 x 292 x 222	332 x 276 x 208	341 x 285	421,2	9003414 82031 9	9003414 89031 2	9003414 86031 5
	4D	348 x 348 x 222	332 x 332 x 208	341 x 341	515	9003414 82034 0	9003414 89034 3	9003414 86034 6
With double door, door opening: 167 x 200 cm (W x H)								
	1B	236 x 180 x 222	220 x 164 x 208	229 x 173	257,6	9003414 81060 0	9003414 87060 4	9003414 85060 6
	2B	236 x 236 x 222	220 x 220 x 208	229 x 229	296,7	9003414 81063 1	9003414 87063 5	9003414 85063 7
	3B	236 x 292 x 222	220 x 276 x 208	229 x 285	361	9003414 81069 3	9003414 87069 7	9003414 85069 9
	4B	236 x 348 x 222	220 x 332 x 208	229 x 341	400	9003414 81072 3	9003414 87072 7	9003414 85072 9
	1C	292 x 180 x 222	276 x 164 x 208	285 x 173	323,9	9003414 82005 0	9003414 89005 3	9003414 86005 6
	2C	292 x 236 x 222	276 x 220 x 208	285 x 229	360,4	9003414 82008 1	9003414 89008 4	9003414 86008 7
	3C	292 x 292 x 222	276 x 276 x 208	285 x 285	441	9003414 82011 1	9003414 89011 4	9003414 86011 7
	4C	292 x 348 x 222	276 x 332 x 208	285 x 341	485,5	9003414 82014 2	9003414 89014 5	9003414 86014 8
	1D	348 x 180 x 222	332 x 164 x 208	341 x 173	351,9	9003414 82044 9	9003414 89044 2	9003414 86044 5
	2D	348 x 236 x 222	332 x 220 x 208	341 x 229	390,5	9003414 82048 7	9003414 89048 0	9003414 86048 3
	3D	348 x 292 x 222	332 x 276 x 208	341 x 285	479,3	9003414 82051 7	9003414 89051 0	9003414 86051 3
	4D	348 x 348 x 222	332 x 332 x 208	341 x 341	526,7	9003414 82054 8	9003414 89054 1	9003414 86054 4
<b>Additions</b>								
Side Canopy for Neo Garden Shed								
	2A-2D	300 x 235 x 220			226,8	9003414 81026 6	9003414 87026 0	9003414 85026 2
	3A-3D	300 x 291 x 220			287,3	9003414 81036 5	9003414 87036 9	9003414 85036 1
	4A-4D	300 x 347 x 220			319,3	9003414 81046 4	9003414 87046 8	9003414 85046 0
Side Wall for Side Canopy								
	2A-2D	203 x 4,3 x 200			65,5	9003414 81028 0	9003414 87028 4	9003414 85028 6
	3A-3D	259 x 4,3 x 200			72,2	9003414 81038 9	9003414 87038 3	9003414 85038 5
	4A-4D	315 x 4,3 x 200			89,7	9003414 81048 8	9003414 87048 2	9003414 85048 4
Back Wall for Side Canopy								
	2A-4D	299 x 4,3 x 200			88,6	9003414 81098 3	9003414 87098 7	9003414 85098 9
Tinted Glass Panel for Side Canopy								
	2A-4D	31,8 x 4,2 x 200			7	9003414 47934 0	9003414 47984 5	9003414 47954 8
FloraBoard for Side Canopy								
	2A-4D	84 x 24 x 197			11,9	9003414 47036 1	9003414 47086 6	9003414 47056 9

\*highest point, incl. roof overhang



Foundation Accessories / Foundation	EAN Code	EAN Code	EAN Code	EAN Code
suitable for	Aluminium Floor Frame	Aluminium Floor Panels	SmartBase	SmartBase <sup>PLUS</sup>
<b>Neo</b>				
<b>1A</b>	9003414 <b>41014</b> 5	9003414 <b>48014</b> 8	9003414 <b>43950</b> 4	9003414 <b>43450</b> 9
<b>1B, 2A</b>	9003414 <b>41024</b> 4	9003414 <b>48024</b> 7	9003414 <b>43954</b> 2	9003414 <b>43454</b> 7
<b>1C, 3A</b>	9003414 <b>41034</b> 3	9003414 <b>48034</b> 6	9003414 <b>43955</b> 9	9003414 <b>43455</b> 4
<b>1D, 4A</b>	9003414 <b>41044</b> 2	9003414 <b>48044</b> 5	9003414 <b>43956</b> 6	9003414 <b>43456</b> 1
<b>2B</b>	9003414 <b>41040</b> 4	9003414 <b>48040</b> 7	9003414 <b>43918</b> 4	9003414 <b>43418</b> 9
<b>2C, 3B</b>	9003414 <b>41054</b> 1	9003414 <b>48054</b> 4	9003414 <b>43960</b> 3	9003414 <b>43460</b> 8
<b>2D, 4B</b>	9003414 <b>41067</b> 1	9003414 <b>48064</b> 3	9003414 <b>43962</b> 7	9003414 <b>43462</b> 2
<b>3C</b>	9003414 <b>41074</b> 9	9003414 <b>48074</b> 2	9003414 <b>43965</b> 8	9003414 <b>43465</b> 3
<b>3D, 4C</b>	9003414 <b>41084</b> 8	9003414 <b>48084</b> 1	9003414 <b>43970</b> 2	9003414 <b>43470</b> 7
<b>4D</b>	9003414 <b>41094</b> 7	9003414 <b>48094</b> 0	9003414 <b>43974</b> 0	9003414 <b>43474</b> 5

Note: Hammer drills can be rented from any well-equipped specialist, however the drill bit required is available from Biohort.

Drill Bit Ø 40 x 570 mm for SDS-MAX chuck Ø 18 mm (for SmartBase<sup>PLUS</sup>)

9003414 **43410** 3

Note: In combination with an additional door, an additional package is required for the SmartBase and SmartBase<sup>PLUS</sup>.

Foundation Additional Package

9003414 **43505** 6

9003414 **43405** 9

Note: If the floor frame is laid directly on a gravel base (approx. 10 cm gravel, without foundation or slabs), ground anchors are required for securing to the ground. Storm resistance must be ensured by the customer. For size 1A, 1B, 2A, 2B: 8 pcs. in total; for size 1C, 3A, 1D, 4A: 10 pcs. in total; for size 2C, 3B, 2D, 4B: 14 pcs. in total; for size 3C, 3D, 4C, 4D: 16 pcs. in total are necessary.









Ground Anchor  
4 pieces per package 9003414 **41004** 6  
6 pieces per package 9003414 **41006** 0

Interior Fittings		EAN Code	EAN Code
suitable for		Interior Panelling	Insulation
Standard Door	Double Door		
<b>1A</b>		9003414 <b>46051</b> 5	9003414 <b>46081</b> 2
<b>1B, 2A</b>		9003414 <b>46052</b> 2	9003414 <b>46082</b> 9
	<b>1B</b>	9003414 <b>46053</b> 9	9003414 <b>46081</b> 2
<b>1C, 3A</b>		9003414 <b>46056</b> 0	9003414 <b>46084</b> 3
	<b>1C</b>	9003414 <b>46057</b> 7	9003414 <b>46082</b> 9
<b>1D, 4A</b>		9003414 <b>46058</b> 4	9003414 <b>46086</b> 7
	<b>1D</b>	9003414 <b>46061</b> 4	9003414 <b>46084</b> 3
<b>2B</b>		9003414 <b>46054</b> 6	9003414 <b>46084</b> 3
	<b>2B</b>	9003414 <b>46055</b> 3	9003414 <b>46082</b> 9
<b>2C, 3B</b>		9003414 <b>46059</b> 1	9003414 <b>46086</b> 7
	<b>2C, 3B</b>	9003414 <b>46060</b> 7	9003414 <b>46084</b> 3
<b>2D, 4B</b>		9003414 <b>46062</b> 1	9003414 <b>46088</b> 1
	<b>2D, 4B</b>	9003414 <b>46064</b> 5	9003414 <b>46086</b> 7
<b>3C</b>		9003414 <b>46063</b> 8	9003414 <b>46088</b> 1
	<b>3C</b>	9003414 <b>46065</b> 2	9003414 <b>46086</b> 7
<b>3D, 4C</b>		9003414 <b>46066</b> 9	9003414 <b>46090</b> 4
	<b>3D, 4C</b>	9003414 <b>46067</b> 6	9003414 <b>46088</b> 1
<b>4D</b>		9003414 <b>46068</b> 3	9003414 <b>46093</b> 5
	<b>4D</b>	9003414 <b>46069</b> 0	9003414 <b>46090</b> 4

Accessories		Dimensions W x L x H (cm)	EAN Code		
Accessories in matching colour					
			Metallic Silver	Metallic Quartz Grey	Metallic Dark Grey
Glass Panel	tinted	32 x 3,3 x 207	9003414 <b>47034</b> 7	9003414 <b>47084</b> 2	9003414 <b>47054</b> 5
Additional Door		83 x 3 x 203	9003414 <b>81002</b> 0	9003414 <b>87002</b> 4	9003414 <b>85002</b> 6
Tool Holder	2 pieces per package	30 x 5 x 3,5	9003414 <b>47032</b> 3	9003414 <b>47082</b> 8	9003414 <b>47052</b> 1
FloraBoard		84 x 24 x 205	9003414 <b>47035</b> 4	9003414 <b>47085</b> 9	9003414 <b>47055</b> 2

Accessories		Dimensions W x L x H (cm)	EAN Code
Accessories made of galvanised steel, grey white coated			
Shelves	2 pieces per package	56 x 26 x 17,3	9003414 <b>45040</b> 0
	4 pieces per package	56 x 26 x 17,3	9003414 <b>45050</b> 9
	2 pieces per package	56 x 44,5 x 17,3	9003414 <b>45060</b> 8
Suspension Basket	With wall bracket	56 x 34 x 20	9003414 <b>47073</b> 6
Hook Set	One combi, handle and shovel hook each	56 x 23 x 10	9003414 <b>47072</b> 9
Tool Hangers	2 pieces per package	28 x 10,4 x 17,2	9003414 <b>47021</b> 7
Door Baskets	2 pieces per package	34 x 10 x 9,5	9003414 <b>46025</b> 6
Shelf Baskets	2 pieces per package	72 x 16 x 11	9003414 <b>46026</b> 3
Threshold Access Ramp	Only with double door and floor frame	170,5 x 9,1 x 3	9003414 <b>41001</b> 5
BikeLift*	Standard	33 x 184 x 28	9003414 <b>49052</b> 9
	Swivel Mount	33 x 184 x 39	9003414 <b>49053</b> 6
Bicycle Hanger BikeMax	1 piece per package	14,5 x 8 x 205,5	9003414 <b>49030</b> 7
BikeHolder	set for 2 bikes	56 x 17,7 x 33	9003414 <b>49032</b> 1
Electric Mounting Panel		28 x 4 x 204	9003414 <b>46034</b> 8
LED Light		44 x 4 x 1,5	9003414 <b>46041</b> 6

# HighLine®, Panorama®, AvantGarde® and AvantGarde®ECO Garden Sheds



HighLine®	Size	Exterior Dimensions*	Interior Dimensions	Foundation Dimensions	Weight	EAN Code		
		W x L x H (cm)	W x L x H (cm)	W x L (cm)	(kg)	Metallic Silver	Metallic Quartz Grey	Metallic Dark Grey
With standard door, door opening: 76 x 182 cm (W x H), right door hinge								
	H5	155 x 275 x 222	132 x 252 x 210	137 x 257	222,8	9003414 83010 3	9003414 88010 8	9003414 84010 2
	H1	275 x 155 x 222	252 x 132 x 210	257 x 137	214,5	9003414 83020 2	9003414 88020 7	9003414 84020 1
	H2	275 x 195 x 222	252 x 172 x 210	257 x 177	232	9003414 83030 1	9003414 88030 6	9003414 84030 0
	H3	275 x 235 x 222	252 x 212 x 210	257 x 217	267,5	9003414 83040 0	9003414 88040 5	9003414 84040 9
	H4	275 x 275 x 222	252 x 252 x 210	257 x 257	283,6	9003414 83050 9	9003414 88050 4	9003414 84050 8
	H5	275 x 315 x 222	252 x 292 x 210	257 x 297	317,8	9003414 83060 8	9003414 88060 3	9003414 84060 7
H6	315 x 315 x 222	292 x 292 x 210	297 x 297	377	9003414 83070 7	9003414 88070 2	9003414 84070 6	
With double door, door opening: 155 x 182 cm (W x H)								
	H1	275 x 155 x 222	252 x 132 x 210	257 x 137	226,9	9003414 83029 5	9003414 88029 0	9003414 84029 4
	H2	275 x 195 x 222	252 x 172 x 210	257 x 177	244,4	9003414 83039 4	9003414 88039 9	9003414 84039 3
	H3	275 x 235 x 222	252 x 212 x 210	257 x 217	279,9	9003414 83049 3	9003414 88049 8	9003414 84049 2
	H4	275 x 275 x 222	252 x 252 x 210	257 x 257	296	9003414 83059 2	9003414 88059 7	9003414 84059 1
	H5	275 x 315 x 222	252 x 292 x 210	257 x 297	330,2	9003414 83069 1	9003414 88069 6	9003414 84069 0
	H6	315 x 315 x 222	292 x 292 x 210	297 x 297	389,4	9003414 83079 0	9003414 88079 5	9003414 84079 9
Additions								
Side canopy size S for HighLine® garden shed, width: 150 cm								
	H2	150 x 195 x 222			75,8	9003414 83836 9	9003414 88836 4	9003414 84836 8
	H3	150 x 235 x 222			86,7	9003414 83846 8	9003414 88846 3	9003414 84846 7
	H4	150 x 275 x 222			94,2	9003414 83856 7	9003414 88856 2	9003414 84856 6
	H5, H6	150 x 315 x 222			104,1	9003414 83866 6	9003414 88866 1	9003414 84866 5
Side canopy size L for HighLine® garden shed, width: 282 cm								
	H2	282 x 195 x 222			115	9003414 83036 3	9003414 88036 8	9003414 84036 2
	H3	282 x 235 x 222			134,6	9003414 83046 2	9003414 88046 7	9003414 84046 1
	H4	282 x 275 x 222			141,3	9003414 83056 1	9003414 88056 6	9003414 84056 0
	H5, H6	282 x 315 x 222			155,8	9003414 83066 0	9003414 88066 5	9003414 84066 9
Side wall for side canopy size S and size L								
	H2	157 x 2,5 x 181			37,8	9003414 83038 7	9003414 88038 2	9003414 84038 6
	H3	197 x 2,5 x 181			45,6	9003414 83048 6	9003414 88048 1	9003414 84048 5
	H4	237 x 2,5 x 181			54,8	9003414 83058 5	9003414 88058 0	9003414 84058 4
	H5, H6	277 x 2,5 x 181			62,8	9003414 83068 4	9003414 88068 9	9003414 84068 3
Back wall for side canopy size S, width: 150 cm								
	S	134 x 4 x 181			33,8	9003414 83097 4	9003414 88097 9	9003414 84097 3
Back wall for side canopy size L, width: 282 cm								
	L	266 x 4 x 181			61,2	9003414 83098 1	9003414 88098 6	9003414 84098 0
Panorama®								
With standard door, door opening: 76 x 182 cm (W x H), right door hinge								
	P1	273 x 158 x 227	252 x 132 x 220	257 x 137	202,2	9003414 13020 3	9003414 18020 8	9003414 14020 2
	P2	273 x 198 x 227	252 x 172 x 220	257 x 177	225,7	9003414 13030 2	9003414 18030 7	9003414 14030 1
	P3	273 x 238 x 227	252 x 212 x 220	257 x 217	250	9003414 13040 1	9003414 18040 6	9003414 14040 0
	P4	273 x 278 x 227	252 x 252 x 220	257 x 257	271,9	9003414 13050 0	9003414 18050 5	9003414 14050 9
	P5	273 x 318 x 227	252 x 292 x 220	257 x 297	293,9	9003414 13060 9	9003414 18060 4	9003414 14060 8
With double door, door opening: 155 x 182 cm (W x H)								
	P1	273 x 158 x 227	252 x 132 x 220	257 x 137	214,6	9003414 13029 6	9003414 18029 1	9003414 14029 5
	P2	273 x 198 x 227	252 x 172 x 220	257 x 177	238,1	9003414 13039 5	9003414 18039 0	9003414 14039 4
	P3	273 x 238 x 227	252 x 212 x 220	257 x 217	262,4	9003414 13049 4	9003414 18049 9	9003414 14049 3
	P4	273 x 278 x 227	252 x 252 x 220	257 x 257	284,3	9003414 13059 3	9003414 18059 8	9003414 14059 2
	P5	273 x 318 x 227	252 x 292 x 220	257 x 297	306,3	9003414 13069 2	9003414 18069 7	9003414 14069 1

\*highest point, incl. roof overhang

AvantGarde®	Size	Exterior Dimensions*	Interior Dimensions	Foundation Dimensions	Weight	EAN Code		
		W x L x H (cm)	W x L x H (cm)	W x L (cm)	(kg)	Metallic Silver	Metallic Quartz Grey	Metallic Dark Grey
With standard door, door opening: 76 x 182 cm (W x H), right door hinge								
	A1	180 x 220 x 218	172 x 172 x 209	177 x 177	155,8	9003414 15010 2	9003414 19010 8	9003414 17010 0
	A2	180 x 260 x 218	172 x 212 x 209	177 x 217	175,7	9003414 15020 1	9003414 19020 7	9003414 17020 9
	A3	180 x 300 x 218	172 x 252 x 209	177 x 257	194,2	9003414 15030 0	9003414 19030 6	9003414 17030 8
	A4	180 x 380 x 222	172 x 332 x 209	177 x 337	237,3	9003414 15040 9	9003414 19040 5	9003414 17040 7
	A5	260 x 220 x 218	252 x 172 x 209	257 x 177	191	9003414 15050 8	9003414 19050 4	9003414 17050 6
	A6	260 x 260 x 218	252 x 212 x 209	257 x 217	214,5	9003414 15060 7	9003414 19060 3	9003414 17060 5
	A7	260 x 300 x 218	252 x 252 x 209	257 x 257	230,8	9003414 15070 6	9003414 19070 2	9003414 17070 4
	A8	260 x 380 x 222	252 x 332 x 209	257 x 337	281,5	9003414 15080 5	9003414 19080 1	9003414 17080 3
With double door, door opening: A1 - A4: 139 x 182 cm (W x H), A5 - A8: 155 x 182 cm (W x H)								
A1	180 x 220 x 218	172 x 172 x 209	177 x 177	167	9003414 15019 5	9003414 19019 1	9003414 17019 3	
A2	180 x 260 x 218	172 x 212 x 209	177 x 217	186,9	9003414 15029 4	9003414 19029 0	9003414 17029 2	
A3	180 x 300 x 218	172 x 252 x 209	177 x 257	202,4	9003414 15039 3	9003414 19039 9	9003414 17039 1	
A4	180 x 380 x 222	172 x 332 x 209	177 x 337	247	9003414 15049 2	9003414 19049 8	9003414 17049 0	
A5	260 x 220 x 218	252 x 172 x 209	257 x 177	203,4	9003414 15059 1	9003414 19059 7	9003414 17059 9	
A6	260 x 260 x 218	252 x 212 x 209	257 x 217	226,9	9003414 15069 0	9003414 19069 6	9003414 17069 8	
A7	260 x 300 x 218	252 x 252 x 209	257 x 257	243,2	9003414 15079 9	9003414 19079 5	9003414 17079 7	
A8	260 x 380 x 222	252 x 332 x 209	257 x 337	293,9	9003414 15089 8	9003414 19089 4	9003414 17089 6	

AvantGarde®ECO	Size	Exterior Dimensions*	Interior Dimensions	Foundation Dimensions	Weight	EAN Code		
		W x L x H (cm)	W x L x H (cm)	W x L (cm)	(kg)	Metallic Silver	Metallic Quartz Grey	Metallic Dark Grey
With standard door, door opening: 76 x 182 cm (W x H), right door hinge								
	A1	180 x 220 x 218	172 x 172 x 209	177 x 177	128	9003414 15610 4	9003414 19610 0	9003414 17610 2
	A2	180 x 260 x 218	172 x 212 x 209	177 x 217	146	9003414 15620 3	9003414 19620 9	9003414 17620 1
	A3	180 x 300 x 218	172 x 252 x 209	177 x 257	161	9003414 15630 2	9003414 19630 8	9003414 17630 0
	A4	180 x 380 x 222	172 x 332 x 209	177 x 337	204	9003414 15640 1	9003414 19640 7	9003414 17640 9
	A5	260 x 220 x 218	252 x 172 x 209	257 x 177	160	9003414 15650 0	9003414 19650 6	9003414 17650 8
	A6	260 x 260 x 218	252 x 212 x 209	257 x 217	182	9003414 15660 9	9003414 19660 5	9003414 17660 7
	A7	260 x 300 x 218	252 x 252 x 209	257 x 257	194	9003414 15670 8	9003414 19670 4	9003414 17670 6
	A8	260 x 380 x 222	252 x 332 x 209	257 x 337	246	9003414 15680 7	9003414 19680 3	9003414 17680 5
With double door, door opening: A1 - A4: 139 x 182 cm (W x H), A5 - A8: 155 x 182 cm (W x H)								
A1	180 x 220 x 218	172 x 172 x 209	177 x 177	133	9003414 15619 7	9003414 19619 3	9003414 17619 5	
A2	180 x 260 x 218	172 x 212 x 209	177 x 217	151	9003414 15629 6	9003414 19629 2	9003414 17629 4	
A3	180 x 300 x 218	172 x 252 x 209	177 x 257	166	9003414 15639 5	9003414 19639 1	9003414 17639 3	
A4	180 x 380 x 222	172 x 332 x 209	177 x 337	215	9003414 15649 4	9003414 19649 0	9003414 17649 2	
A5	260 x 220 x 218	252 x 172 x 209	257 x 177	163	9003414 15659 3	9003414 19659 9	9003414 17659 1	
A6	260 x 260 x 218	252 x 212 x 209	257 x 217	185	9003414 15669 2	9003414 19669 8	9003414 17669 0	
A7	260 x 300 x 218	252 x 252 x 209	257 x 257	197	9003414 15679 1	9003414 19679 7	9003414 17679 9	
A8	260 x 380 x 222	252 x 332 x 209	257 x 337	249	9003414 15689 0	9003414 19689 6	9003414 17689 8	

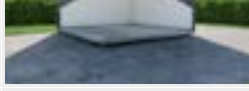
\*highest point, incl. roof overhang

Foundation Accessories / Foundations			EAN Code	EAN Code	EAN Code	EAN Code
suitable for			Aluminium Floor Frame	Aluminium Floor Panels	SmartBase	SmartBase <sup>PLUS</sup>
HighLine®	Panorama®	AvantGarde®				
		AvantGarde®ECO				
		A1	9003414 41031 2	9003414 48031 5	9003414 43946 7	9003414 43446 2
		A2	9003414 41071 8	9003414 48071 1	9003414 43988 7	9003414 43488 2
H1, HS	P1		9003414 41022 0	9003414 48022 3	9003414 43952 8	9003414 43452 3
H2	P2	A3, A5	9003414 41041 1	9003414 48041 4	9003414 43958 0	9003414 43458 5
		A4	9003414 41081 7	9003414 48081 0	9003414 43976 4	9003414 43476 9
H3	P3	A6	9003414 41042 8	9003414 48042 1	9003414 43963 4	9003414 43463 9
H4	P4	A7	9003414 41051 0	9003414 48051 3	9003414 43968 9	9003414 43468 4
H5	P5		9003414 41062 6	9003414 48062 9	9003414 43973 3	9003414 43473 8
		A8	9003414 41061 9	9003414 48061 2	9003414 43978 8	9003414 43478 3
H6			9003414 41043 5	9003414 48043 8	9003414 43995 5	9003414 43495 0

Note: Hammer drills can be rented from any well-equipped specialist, however the drill bit required is available from Biohort.

Drill Bit Ø 40 x 570 mm for SDS-MAX chuck Ø 18 mm (for SmartBase<sup>PLUS</sup>) 9003414 43410 3





Note: In combination with an additional door, an additional package is required for the SmartBase and SmartBase<sup>PLUS</sup>.

Foundation Additional Package 9003414 43505 6 9003414 43405 9



Note: If the floor frame is laid directly on a gravel base (approx. 10 cm gravel, without foundation or slabs), ground anchors are required for securing to the ground. Storm resistance must be ensured by the customer. For size A1,HS, H1, P1: 8 pcs. in total; for size H2, P2, A2, H3, P3, A3, A4, A5, A6: 10 pcs. in total; for size H4, P4, H5, P5, H6 A7, A8: 12 pcs. in total are necessary.

Ground Anchor	4 pieces per package	9003414 41004 6
	6 pieces per package	9003414 41006 0



Accessories		Dimensions W x L x H (cm) / Colour				
Accessories in matching colour			HighLine*	Panorama*	AvantGarde*	AvantGarde*ECO
Additional Door	With stainless steel door handle and gas spring	Metallic Silver	9003414 <b>83002</b> 8	9003414 <b>83002</b> 8	9003414 <b>83002</b> 8	
		Metallic Quartz Grey	9003414 <b>88002</b> 3	9003414 <b>88002</b> 3	9003414 <b>88002</b> 3	
		Metallic Dark Grey	9003414 <b>84002</b> 7	9003414 <b>84002</b> 7	9003414 <b>84002</b> 7	
Additional Door ECO	Corrugated, with T-handle cylinder lock and door hooks	Metallic Silver				9003414 <b>83602</b> 0
		Metallic Quartz Grey				9003414 <b>88602</b> 5
		Metallic Dark Grey				9003414 <b>84602</b> 9
Window Uni		Metallic Silver	9003414 <b>43065</b> 5	9003414 <b>43065</b> 5	9003414 <b>43065</b> 5	9003414 <b>43065</b> 5
		Metallic Quartz Grey	9003414 <b>43085</b> 3	9003414 <b>43085</b> 3	9003414 <b>43085</b> 3	9003414 <b>43085</b> 3
		Metallic Dark Grey	9003414 <b>43055</b> 6	9003414 <b>43055</b> 6	9003414 <b>43055</b> 6	9003414 <b>43055</b> 6
Rainwater Downpipe Set		Metallic Silver	9003414 <b>44025</b> 8	9003414 <b>44024</b> 1	9003414 <b>44022</b> 7	9003414 <b>44022</b> 7
		Metallic Quartz Grey	9003414 <b>44085</b> 2	9003414 <b>44084</b> 5	9003414 <b>44082</b> 1	9003414 <b>44082</b> 1
		Metallic Dark Grey	9003414 <b>44065</b> 4	9003414 <b>44064</b> 7	9003414 <b>44062</b> 3	9003414 <b>44062</b> 3
FloraBoard		Metallic Silver	9003414 <b>47030</b> 9	9003414 <b>47030</b> 9	9003414 <b>47030</b> 9	9003414 <b>47030</b> 9
		Metallic Quartz Grey	9003414 <b>47080</b> 4	9003414 <b>47080</b> 4	9003414 <b>47080</b> 4	9003414 <b>47080</b> 4
		Metallic Dark Grey	9003414 <b>47050</b> 7	9003414 <b>47050</b> 7	9003414 <b>47050</b> 7	9003414 <b>47050</b> 7
Tool Holder	2 pieces per package	Metallic Silver	9003414 <b>47031</b> 6	9003414 <b>47031</b> 6	9003414 <b>47031</b> 6	
		Metallic Quartz Grey	9003414 <b>47081</b> 1	9003414 <b>47081</b> 1	9003414 <b>47081</b> 1	
		Metallic Dark Grey	9003414 <b>47051</b> 4	9003414 <b>47051</b> 4	9003414 <b>47051</b> 4	
Tool Holder ECO	2 pieces per package for ECO doors	Metallic Silver				9003414 <b>47032</b> 3
		Metallic Quartz Grey				9003414 <b>47082</b> 8
		Metallic Dark Grey				9003414 <b>47052</b> 1
Made from hot-dip galvanised, polyamide coated steel plate						
Shelf Support Rails	2 pieces per package	4 x 4 x 185	9003414 <b>46021</b> 8	9003414 <b>46021</b> 8	9003414 <b>46021</b> 8	9003414 <b>46021</b> 8
Shelves	2 pieces per package	72 x 24,5 x 7,5	9003414 <b>45010</b> 3	9003414 <b>45010</b> 3	9003414 <b>45010</b> 3	9003414 <b>45010</b> 3
	4 pieces per package	72 x 24,5 x 7,5	9003414 <b>45020</b> 2	9003414 <b>45020</b> 2	9003414 <b>45020</b> 2	9003414 <b>45020</b> 2
	2 pieces per package	72 x 43,5 x 12,5	9003414 <b>45030</b> 1	9003414 <b>45030</b> 1	9003414 <b>45030</b> 1	9003414 <b>45030</b> 1
Folding Table		69,2 x 57,5 x 40	9003414 <b>40011</b> 5	9003414 <b>40011</b> 5	9003414 <b>40011</b> 5	9003414 <b>40011</b> 5
Suspension Basket	With wall bracket	67 x 34 x 20	9003414 <b>47071</b> 2	9003414 <b>47071</b> 2	9003414 <b>47071</b> 2	9003414 <b>47071</b> 2
Hook Set	One combi, handle and shovel hook each	72 x 17 x 73	9003414 <b>47070</b> 5	9003414 <b>47070</b> 5	9003414 <b>47070</b> 5	9003414 <b>47070</b> 5
Tool Hangers	4 pieces per package	13 x 9,5 x 30	9003414 <b>47020</b> 0	9003414 <b>47020</b> 0	9003414 <b>47020</b> 0	9003414 <b>47020</b> 0
Door Baskets	2 pieces per package	34 x 10 x 9,5	9003414 <b>46025</b> 6	9003414 <b>46025</b> 6	9003414 <b>46025</b> 6	9003414 <b>46025</b> 6
Shelf Baskets	2 pieces per package	72 x 16 x 11	9003414 <b>46026</b> 3	9003414 <b>46026</b> 3	9003414 <b>46026</b> 3	9003414 <b>46026</b> 3
Threshold Access Ramp	Only with double door and floor frame	135 x 14,5 x 7	9003414 <b>41000</b> 8	9003414 <b>41000</b> 8	9003414 <b>41000</b> 8	9003414 <b>41000</b> 8
BikeLift*	Standard	33 x 184 x 27,5	9003414 <b>49050</b> 5	9003414 <b>49050</b> 5	9003414 <b>49050</b> 5	9003414 <b>49050</b> 5
	Swivel Mount	33 x 184 x 38,5	9003414 <b>49051</b> 2	9003414 <b>49051</b> 2	9003414 <b>49051</b> 2	9003414 <b>49051</b> 2
Bicycle Hanger BikeMax	1 piece per package	4 x 4 x 185	9003414 <b>49011</b> 6	9003414 <b>49011</b> 6	9003414 <b>49011</b> 6	9003414 <b>49011</b> 6
	2 pieces per package		9003414 <b>49021</b> 5	9003414 <b>49021</b> 5	9003414 <b>49021</b> 5	9003414 <b>49021</b> 5
BikeHolder	set for 3 bikes	72 x 10 x 33	9003414 <b>49012</b> 3	9003414 <b>49012</b> 3	9003414 <b>49012</b> 3	9003414 <b>49012</b> 3
Electric Mounting Panel		20 x 4 x 185	9003414 <b>46031</b> 7	9003414 <b>46031</b> 7	9003414 <b>46031</b> 7	9003414 <b>46031</b> 7
LED Light		44 x 4 x 1,5	9003414 <b>46041</b> 6	9003414 <b>46041</b> 6	9003414 <b>46041</b> 6	9003414 <b>46041</b> 6
Gas springs are standard in the standard equipment! Exceptions: AvantGarde*ECO and additional door ECO						
Gas Spring Set for ECO doors	1 piece per package	34 x 2 x 2				9003414 <b>83608</b> 2
	2 pieces per package	34 x 2 x 2				9003414 <b>83609</b> 9





## Accessories Europa Garden Shed and Equipment Locker

Europa	Size	Exterior Dimensions*	Interior Dimensions	Foundation Dimensions	Weight (kg)	EAN Code				
		W x L x H (cm)	W x L x H (cm)	W x L (cm)		Metallic Silver	Metallic Quartz Grey	Metallic Dark Grey	Dark Green	
	Door opening: 135 x 170 cm (W x H)									
	1	172 x 84 x 196	150 x 78 x 188	155 x 83	90,4	9003414 <b>29010</b> 5	9003414 <b>22010</b> 2	9003414 <b>24010</b> 0	9003414 <b>23010</b> 1	
	2	172 x 156 x 196	150 x 150 x 188	155 x 155	115,2	9003414 <b>29020</b> 4	9003414 <b>22020</b> 1	9003414 <b>24020</b> 9	9003414 <b>23020</b> 0	
	3	244 x 156 x 203	222 x 150 x 195	227 x 155	139,4	9003414 <b>29030</b> 3	9003414 <b>22030</b> 0	9003414 <b>24030</b> 8	9003414 <b>23030</b> 9	
	4	244 x 228 x 203	222 x 222 x 195	227 x 227	167,8	9003414 <b>29040</b> 2	9003414 <b>22040</b> 9	9003414 <b>24040</b> 7	9003414 <b>23040</b> 8	
	5	316 x 228 x 209	294 x 222 x 202	299 x 227	202,6	9003414 <b>29050</b> 1	9003414 <b>22050</b> 8	9003414 <b>24050</b> 6	9003414 <b>23050</b> 7	
	6	244 x 300 x 203	222 x 294 x 195	227 x 299	197,8	9003414 <b>29060</b> 0	9003414 <b>22060</b> 7	9003414 <b>24060</b> 5	9003414 <b>23060</b> 6	
	7	316 x 300 x 209	294 x 294 x 202	299 x 299	233,9	9003414 <b>29070</b> 9	9003414 <b>22070</b> 6	9003414 <b>24070</b> 4	9003414 <b>23070</b> 5	
	2A	244 x 84 x 203	222 x 78 x 195	227 x 83	112,2	9003414 <b>29080</b> 8	9003414 <b>22080</b> 5	9003414 <b>24080</b> 3	9003414 <b>23080</b> 4	
	4A	316 x 156 x 209	294 x 150 x 202	299 x 155	165,1	9003414 <b>29090</b> 7	9003414 <b>22090</b> 4	9003414 <b>24090</b> 2	9003414 <b>23090</b> 3	
Additions	Side Canopy for Europa garden shed									
	2,3,4A	150 x 156 x 170			21,7	9003414 <b>42019</b> 9	9003414 <b>42012</b> 0	9003414 <b>42014</b> 4	9003414 <b>42040</b> 3	
	4,5	150 x 228 x 170			27,5	9003414 <b>42029</b> 8	9003414 <b>42022</b> 9	9003414 <b>42024</b> 3	9003414 <b>42050</b> 2	
	6,7	150 x 300 x 170			35,2	9003414 <b>42039</b> 7	9003414 <b>42032</b> 8	9003414 <b>42034</b> 2	9003414 <b>42060</b> 1	

\*highest point, incl. roof overhang

Equipment Locker	Size	Exterior Dimensions*	Interior Dimensions	Foundation Dimensions	Weight (kg)	EAN Code		
		W x L x H (cm)	W x L x H (cm)	W x L (cm)		Metallic Silver	Metallic Quartz Grey	Metallic Dark Grey
	Door opening: Size 90: 65 x 170 cm (W x H), from size 150: 135 x 170 cm (W x H)							
	90	93 x 83 x 182,5	88 x 78 x 177	93 x 83	56,4	9003414 34030 5	9003414 30030 9	9003414 31030 8
	150	155 x 83 x 182,5	150 x 78 x 177	155 x 83	88,1	9003414 34010 7	9003414 30010 1	9003414 31010 0
	150 <sup>LARGE</sup>	156 x 155 x 184	150 x 150 x 177	155 x 155	ca. 110,2	9003414 34910 0	9003414 30910 4	9003414 31910 3
	190	191 x 83 x 182,5	186 x 78 x 177	191 x 83	101,4	9003414 34060 2	9003414 30060 6	9003414 31060 5
	190 <sup>LARGE</sup>	192 x 155 x 184	186 x 150 x 177	191 x 155	ca. 124,1	9003414 34960 5	9003414 30960 9	9003414 31960 8
	230	227 x 83 x 182,5	222 x 78 x 177	227 x 83	109,9	9003414 34080 0	9003414 30080 4	9003414 31080 3
	230 <sup>LARGE</sup>	228 x 155 x 184	222 x 150 x 177	227 x 155	ca. 133,7	9003414 34980 3	9003414 30980 7	9003414 31980 6

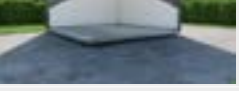
\*highest point, incl. roof overhang

Foundation Accessories / Foundations		Aluminium Floor Frame	Aluminium Floor Panels	SmartBase	SmartBase <sup>PLUS</sup>
Europa	Equipment Locker				
	90	9003414 41011 4	9003414 48011 7	9003414 43982 5	9003414 43482 0
1	150	9003414 41010 7	9003414 48010 0	9003414 43901 6	9003414 43401 1
2	150 <sup>LARGE</sup>	9003414 41020 6	9003414 48020 9	9003414 43906 1	9003414 43406 6
	190	9003414 41012 1	9003414 48012 4	9003414 43929 0	9003414 43426 4
	190 <sup>LARGE</sup>	9003414 41015 2	9003414 48015 5	9003414 43910 8	9003414 43510 0
2A	230	9003414 41080 0	9003414 48080 3	9003414 43936 8	9003414 43436 3
3	230 <sup>LARGE</sup>	9003414 41030 5	9003414 48030 8	9003414 43912 2	9003414 43412 7
4		9003414 41040 4	9003414 48040 7	9003414 43918 4	9003414 43418 9
4A		9003414 41090 9	9003414 48090 2	9003414 43942 9	9003414 43442 4
5,6		9003414 41050 3	9003414 48050 6	9003414 43923 8	9003414 43423 3
7		9003414 41070 1	9003414 48070 4	9003414 43930 6	9003414 43430 1

Note: Hammer drills can be rented from any well-equipped specialist, however the drill bit required is available from Biohort.

Drill Bit Ø 40 x 570 mm for SDS-MAX chuck Ø 18 mm (for SmartBase <sup>PLUS</sup> )	9003414 43410 3
--	-----------------

Note: If the floor frame is laid directly on a gravel base (approx. 10 cm gravel, without foundation or slabs), ground anchors are required for securing to the ground. Storm resistance must be ensured by the customer. For sizes 1, 90, 150: 4 pcs. in total; for sizes 2, 2A, 150<sup>LARGE</sup>, 190, 190<sup>LARGE</sup>, 230: 6 pcs. in total; for sizes 3, 4, 4A, 230<sup>LARGE</sup>: 8 pcs. in total; for sizes 5, 6, 7: 10 pcs. in total.

Ground Anchor	4 pieces per package	9003414 41004 6
	6 pieces per package	9003414 41006 0

Accessories	Dimensions W x L x H (cm) / Colour		
Accessories in matching colour			
Additional Door Double	Corrugated, with T-handle cylinder lock and door hooks	Metallic Silver	9003414 29001 3
		Metallic Quartz Grey	9003414 22001 0
		Metallic Dark Grey	9003414 24001 8
		Dark Green	9003414 23001 9
Rainwater Downpipe Set		Metallic Silver	9003414 44070 8
		Metallic Quartz Grey	9003414 44080 7
		Metallic Dark Grey	9003414 44050 0
		Dark Green	9003414 44040 1
Window Unit		Metallic Silver	9003414 43060 0
		Metallic Quartz Grey	9003414 43080 8
		Metallic Dark Grey	9003414 43050 1
		Dark Green	9003414 43040 2

Made from hot-dip galvanised, polyamide coated steel plate

Shelf Support Rails	2 pieces per package	4 x 4 x 173	9003414 46020 1	9003414 46020 1
Shelves	2 pieces per package	72 x 24,5 x 7,5	9003414 45010 3	9003414 45010 3
	4 pieces per package	72 x 24,5 x 7,5	9003414 45020 2	9003414 45020 2
	2 pieces per package	72 x 43,5 x 12,5	9003414 45030 1	9003414 45030 1
Folding Table		69,2 x 57,5 x 40	9003414 40011 5	9003414 40011 5
Suspension Basket	With wall bracket	67 x 34 x 20	9003414 47071 2	9003414 47071 2
Hook Set	One combi, handle and shovel hook each	72 x 17 x 73	9003414 47070 5	9003414 47070 5
Tool Hangers	4 pieces per package	13 x 9,5 x 30	9003414 47020 0	9003414 47020 0
Door Baskets	2 pieces per package	34 x 10 x 9,5	9003414 46025 6	9003414 46025 6
Shelf Baskets	2 pieces per package	72 x 16 x 11	9003414 46026 3	9003414 46026 3
Electric Mounting Panel		28 x 6 x 172,5	9003414 46030 0	9003414 46030 0
LED Light		44 x 4 x 1,5	9003414 46041 6	9003414 46041 6
Threshold Access Ramp	Only with double door and floor frame	135 x 14,5 x 7	9003414 41000 8	
BikeLift®	Standard	33 x 184 x 27,5	9003414 49050 5	
	Swivel Mount. Can only be mounted centrally on the back wall	33 x 184 x 38,5	9003414 49051 2	
Bicycle Hanger BikeMax	1 piece per package	4 x 4 x 173	9003414 49010 9	
	2 pieces per package		9003414 49020 8	
BikeHolder	set for 3 bikes	72 x 10 x 33	9003414 49012 3	

## Outdoor Living



### CasaNova® – Your High Quality Utility Room

Thanks to the modular construction, there are no limits to your wishes. Doors and windows can be positioned freely according to your expectations. More information at [www.biohort.com/casanova](http://www.biohort.com/casanova).

Product Info



### CasaVita® – Your Extended Living Space

Available in **two colours** and **ten sizes**.

The full range of variants, accessories and technical details can be found at [www.biohort.com/casavita](http://www.biohort.com/casavita).

Only available by selected dealers.

Product Info





## Pergola





	Size	Exterior Dimensions	Interior Dimensions	Weight (kg)	Colour Combination			EAN Code
		W x L x H (cm)	W x L x H (cm)		Frame Colour	Louvre Colour	Variants	
	3x3	312 x 312 x 255	272 x 272 x 235	227,2	Metallic Quartz Grey	Metallic Quartz Grey	1	9003414 92217 4
						Metallic Silver	1.2	9003414 92219 8
					Metallic Dark Grey	Metallic Dark Grey	1.3	9003414 92216 7
						Metallic Silver	1.4	9003414 92218 1
	3,5x3	367,5 x 312 x 255	328 x 272 x 235	256	Metallic Quartz Grey	Metallic Quartz Grey	2	9003414 92221 1
						Metallic Silver	2.2	9003414 92223 5
					Metallic Dark Grey	Metallic Dark Grey	2.3	9003414 92220 4
						Metallic Silver	2.4	9003414 92222 8
	4x3	404,5 x 312 x 255	365 x 272 x 235	275,1	Metallic Quartz Grey	Metallic Quartz Grey	3	9003414 92225 9
						Metallic Silver	3.2	9003414 92227 3
					Metallic Dark Grey	Metallic Dark Grey	3.3	9003414 92224 2
						Metallic Silver	3.4	9003414 92226 6
	3x3,5	312 x 367,5 x 255	272 x 328 x 235	254,6	Metallic Quartz Grey	Metallic Quartz Grey	4	900341492389 8
						Metallic Silver	4.2	900341492391 1
					Metallic Dark Grey	Metallic Dark Grey	4.3	900341492388 1
						Metallic Silver	4.4	9003414 92390 4
	3,5x3,5	367,5 x 367,5 x 255	328 x 328 x 235	288	Metallic Quartz Grey	Metallic Quartz Grey	5	9003414 92229 7
						Metallic Silver	5.2	9003414 92231 0
					Metallic Dark Grey	Metallic Dark Grey	5.3	9003414 92228 0
						Metallic Silver	5.4	9003414 92230 3
	4x3,5	404,5 x 367,5 x 255	365 x 328 x 235	310,2	Metallic Quartz Grey	Metallic Quartz Grey	6	9003414 92233 4
						Metallic Silver	6.2	9003414 92235 8
					Metallic Dark Grey	Metallic Dark Grey	6.3	9003414 92232 7
						Metallic Silver	6.4	9003414 92234 1
Accessories	Size		Weight (kg)	EAN Code				
Electric Motor	for all sizes		3	9003414 92242 6				
Control Set EU / CH / UK	for all sizes		3	EU	9003414 92624 0			
				CH	9003414 93301 9			
				UK	9003414 93302 6			
Sun Screen	for 3 m side		22,9	9003414 92236 5	9003414 92237 2			
	for 3,5 m side		26,3	9003414 92238 9	9003414 92239 6			
	for 4 m side		28,6	9003414 92240 2	9003414 92241 9			
Louvred Side Wall	for 3 m side		110	9003414 92243 3	9003414 92244 0			
	for 3,5 m side		130	9003414 92245 7	9003414 92246 4			
	for 4 m side		143,5	9003414 92247 1	9003414 92248 8			
LED Lighting, warm white	3x3		2,5	9003414 92626 4				
	3,5x3, 3x3,5			9003414 92627 1				
	4x3			9003414 92628 8				
	3,5x3,5			9003414 92629 5				
	4x3,5			9003414 92630 1				



# Privacy Screen

Privacy Screen Panel without Acrylic Glass	Size	Exterior Dimensions		Weight		EAN Code		
		W x L x H (cm)		(kg)		Metallic Silver	Metallic Quartz Grey	Metallic Dark Grey
<b>Height: 90 cm</b> Consists of wall panels and two guide rails for the assembly between two privacy screen posts, can also be attached to a house wall or similar								
	<b>100 x 90</b>	96 x 4,4 x 91		13,2		9003414 15924 2	9003414 15920 4	9003414 15892 4
	<b>150 x 90</b>	145 x 4,4 x 91		17,7		9003414 15925 9	9003414 15921 1	9003414 15893 1
	<b>180 x 90</b>	180 x 4,4 x 91		21,5		9003414 15926 6	9003414 15922 8	9003414 15894 8
	<b>200 x 90</b>	194 x 4,4 x 91		22,9		9003414 15928 0	9003414 15923 5	9003414 15917 4
<b>Height: 135 cm</b> Consists of wall panels and two guide rails for the assembly between two privacy screen posts, can also be attached to a house wall or similar								
	<b>100 x 135</b>	96 x 4,4 x 137		20,3		9003414 15981 5	9003414 15977 8	9003414 15973 0
	<b>150 x 135</b>	145 x 4,4 x 137		27,2		9003414 15982 2	9003414 15978 5	9003414 15974 7
	<b>180 x 135</b>	180 x 4,4 x 137		33,4		9003414 15983 9	9003414 15979 2	9003414 15975 4
	<b>200 x 135</b>	194 x 4,4 x 137		35,5		9003414 15984 6	9003414 15980 8	9003414 15976 1
<b>Height: 180 cm</b> Consists of wall panels and two guide rails for the assembly between two privacy screen posts, can also be attached to a house wall or similar								
	<b>100 x 180</b>	96 x 4,4 x 182		25,7		9003414 16046 0	9003414 16042 2	9003414 16038 5
	<b>150 x 180</b>	145 x 4,4 x 182		34,7		9003414 16047 7	9003414 16043 9	9003414 16039 2
	<b>180 x 180</b>	180 x 4,4 x 182		42,3		9003414 16048 4	9003414 16044 6	9003414 16040 8
	<b>200 x 180</b>	194 x 4,4 x 182		45,1		9003414 16049 1	9003414 16045 3	9003414 16041 5

Privacy Screen Panel with Acrylic Glass	Size	Exterior Dimensions		Weight		EAN Code		
		W x L x H (cm)		(kg)		Metallic Silver	Metallic Quartz Grey	Metallic Dark Grey
<b>Height: 90 cm</b> Consists of wall panels, tinted glass panel and two guide rails for the assembly between two privacy screen posts, can also be attached to a house wall or similar								
	<b>100 x 90</b>	96 x 4,4 x 91		13,1		9003414 15969 3	9003414 15965 5	9003414 15961 7
	<b>150 x 90</b>	145 x 4,4 x 91		17,7		9003414 15970 9	9003414 15966 2	9003414 15962 4
	<b>180 x 90</b>	180 x 4,4 x 91		21,1		9003414 15971 6	9003414 15967 9	9003414 15963 1
	<b>200 x 90</b>	194 x 4,4 x 91		22,3		9003414 15972 3	9003414 15968 6	9003414 15964 8
<b>Height: 135 cm</b> Consists of wall panels, tinted glass panel and two guide rails for the assembly between two privacy screen posts, can also be attached to a house wall or similar								
	<b>100 x 135</b>	96 x 4,4 x 137		20,2		9003414 16034 7	9003414 15989 1	9003414 15985 3
	<b>150 x 135</b>	145 x 4,4 x 137		27,2		9003414 16035 4	9003414 15990 7	9003414 15986 0
	<b>180 x 135</b>	180 x 4,4 x 137		33		9003414 16036 1	9003414 15991 4	9003414 15987 7
	<b>200 x 135</b>	194 x 4,4 x 137		34,9		9003414 16037 8	9003414 15992 1	9003414 15988 4
<b>Height: 180 cm</b> Consists of wall panels, tinted glass panel and two guide rails for the assembly between two privacy screen posts, can also be attached to a house wall or similar								
	<b>100 x 180</b>	96 x 4,4 x 182		25,6		9003414 16058 3	9003414 16054 5	9003414 16050 7
	<b>150 x 180</b>	145 x 4,4 x 182		34,7		9003414 16059 0	9003414 16055 2	9003414 16051 4
	<b>180 x 180</b>	180 x 4,4 x 182		41,9		9003414 16060 6	9003414 16056 9	9003414 16052 1
	<b>200 x 180</b>	194 x 4,4 x 182		44,5		9003414 16229 7	9003414 16057 6	9003414 16053 8

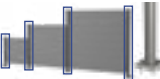
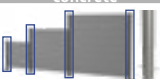
Post for Privacy Screen	suitable for height	Min. Height Max. Height	Base Plate*		Weight (kg)	EAN Code		
			W x L (cm)			Metallic Silver	Metallic Quartz Grey	Metallic Dark Grey
<b>Post for anchoring</b> They are bolted to the ground. For surface anchoring, the posts can be used as starting, end, corner or connecting post for the privacy screen panels. Choose the wall panels to match the height of the post! Diameter: 10 cm. One post per article.								
	<b>90 cm</b>	<b>95 – 120</b>	15 x 15		10,5	9003414 16342 3	9003414 16341 6	9003414 16340 9
	<b>135 cm</b>	<b>140 – 165</b>	15 x 15		11,4	9003414 16345 4	9003414 16344 7	9003414 16343 0
	<b>180 cm</b>	<b>185 – 210</b>	15 x 15		13,1	9003414 16348 5	9003414 16347 8	9003414 16346 1
<b>Post for setting in concrete</b> Are embedded in a point foundation. For surface anchoring, the posts can be used as starting, end, corner or connecting post for the privacy screen panels. Choose the wall panels to match the height of the post! Diameter: 10 cm. One post per article.								
	<b>90 cm</b>	<b>95 – 120</b>			10,2	9003414 17336 1	9003414 17342 2	9003414 17339 2
	<b>135 cm</b>	<b>140 – 165</b>			11,7	9003414 17337 8	9003414 17343 9	9003414 17340 8
	<b>180 cm</b>	<b>185 – 210</b>			13,8	9003414 17338 5	9003414 17344 6	9003414 17341 5

\*The cover plate of the base plate has the dimensions 18 x 18 cm.

Mounting Accessories	For Anchored Post	EAN Code
<b>Hammer Drill Bit</b>	The hammer drill bit is used to drill the required holes in the concrete foundation for the injection mortar. A hammer drill is available in specialist shops.	for SDS plus chuck Ø14 mm Length: 150 mm 9003414 18784 9
<b>Blow-out Pump and Cleaning Brush</b>	The pump is used for a safe and easy cleaning of the drill hole. The cleaning brush is used to remove any dust from the sides of the drill hole. This ensures that the injection mortar adheres to the concrete foundation.	9003414 18785 6
<b>Injection Mortar</b>	The injection mortar is required to bond the threaded rod anchors securely in the concrete.	Content 300 ml Sufficient for minimum of 16 pcs. Anchor rods M12 x 160 9003414 18782 5
<b>Applicator Gun</b>	The injection mortar is precisely applied with the aid of the applicator gun. This is achieved by transmission without great effort.	Suitable for 310 ml cartridges 9003414 18783 2
<b>Threaded Rod Anchors</b>	The anchors are glued into the foundation and guarantee a secure connection between foundation and Biohort Privacy Screen including base plate. Per article 4 pcs. – is enough for a post.	M12 x 160 R Includes nuts and washers 9003414 18786 3

## Outdoor Boxes, Bicycle Storage and Wheelie Bin Storage

Romeo*	Size	Exterior Dimensions	Interior Dimensions	Volume	Weight	EAN Code		
		W x L x H (cm)	W x L x H (cm)	(L)	(kg)	Metallic Silver	Metallic Quartz Grey	Metallic Dark Grey
	M	132 x 57 x 140	127 x 46 x 135	800	68,1	9003414 55070 4	9003414 58070 1	9003414 56070 3
	L	132 x 87 x 140	127 x 76 x 135	1300	81,9	9003414 55080 3	9003414 58080 0	9003414 56080 2
	M <sup>HIGH</sup>	132 x 57 x 181	127 x 46 x 176	1100	60,3	9003414 55010 0	9003414 58010 7	9003414 56010 9
	L <sup>HIGH</sup>	132 x 87 x 181	127 x 76 x 176	1700	74,5	9003414 55020 9	9003414 58020 6	9003414 56020 8
Accessories		for size		Dimensions W x L x H (cm)		EAN Code		
Shelves		for all sizes		61 x 43 x 40 (2-part)		9003414 75055 5		

StoreMax*	Size	Exterior Dimensions	Interior Dimensions	Volume	Weight	EAN Code		
		W x L x H (cm)	W x L (cm)	(L)	(kg)	Metallic Silver	Metallic Quartz Grey	Metallic Dark Grey
	120	117 x 73 x 109	114 x 62	740	48,2	9003414 72060 2	9003414 70060 4	9003414 73060 1
	160	163 x 78 x 120	160 x 67	1200	65,1	9003414 72010 7	9003414 70010 9	9003414 73010 6
	190	190 x 97 x 136	188 x 86	2080	88,8	9003414 72020 6	9003414 70020 8	9003414 73020 5
Accessories		for size		Dimensions W x L x H (cm)		EAN Code		
Corner Shelf Set (triangular)		120, 160		54 x 54 x 53,5		9003414 74010 5		
Intermediate Floor		160		160 (2 x 80) x 59,5 x 53,5		9003414 75010 4		
		190		187 (2 x 93,5) x 74,5 x 53,5		9003414 75020 3		
Shelf Set		190		72 x 24,5 x 53,5		9003414 74020 4		
BikeHolder		190		72 x 15 x 33		9003414 74030 3		

HighBoard	Size	Exterior Dimensions	Interior Dimensions	Volume	Weight	EAN Code		
		W x L x H (cm)	W x L x H (cm)	(L)	(kg)	Metallic Silver	Metallic Quartz Grey	Metallic Dark Grey
	160	160,5 x 70,5 x 118	156 x 62 x 113	1150	82,7	9003414 72015 2	9003414 70015 4	9003414 73015 1
	200	200,5 x 84,5 x 127	195 x 76 x 120	2150	114,5	9003414 72025 1	9003414 70025 3	9003414 73025 0
Accessories		for size		Dimensions W x L x H (cm)		EAN Code		
Tool Holder		160, 200		51,6 x 3,5 x 5		9003414 47031 6	9003414 47081 1	9003414 47051 4
Lid Storage Net		160, 200		25 x 67 x 2		9003414 67010 5		
		160		78 x 30 x 53,5 per shelf (4-pieces)		9003414 75015 9		
Intermediate Floor		200		97 x 74 x 53,5 per shelf (2-pieces)		9003414 75025 8		
		160		54,5 x 50 x 20		9003414 67071 6		
Suspension Basket, Type B		200		68,5 x 67 x 20		9003414 67072 3		
Suspension Basket, Type C		200		72 x 10 x 33		9003414 49012 3		
BikeHolder		200		58 x 2 x 23		9003414 46032 4		
Electric Mounting Panel		200						

LoungeBox*	Size	Exterior Dimensions	Interior Dimensions	Volume	Weight	EAN Code		
		W x L x H (cm)	W x L x H (cm)	(L)	(kg)	Metallic Silver	Metallic Quartz Grey	Metallic Dark Grey
	160	160 x 70 x 83,5	159 x 66 x 77	850	50,1	9003414 64065 8	9003414 68065 4	9003414 65065 7
	200	200 x 85 x 90	199 x 80 x 81	1400	71,9	9003414 64075 7	9003414 68075 3	9003414 65075 6
Accessories		for size		Dimensions W x L x H (cm)		EAN Code		
Lid Storage Net		for all sizes		25 x 67 x 2		9003414 67010 5		
Suspension Basket, Type B		160		54,5 x 50 x 20		9003414 67071 6		
Suspension Basket, Type C		200		68,5 x 67 x 20		9003414 67072 3		

StyleBox*	Size	Exterior Dimensions	Interior Dimensions	Volume	Weight	EAN Code		
		W x L x H (cm)	W x L x H (cm)	(L)	(kg)	Metallic Silver	Metallic Quartz Grey	Metallic Dark Grey
	140	140 x 60 x 71	129 x 49 x 63	400	43,96	9003414 19830 2	9003414 19832 6	9003414 19831 9
	170	170 x 70 x 81	159 x 59 x 73	685	58,90	9003414 19833 3	9003414 19835 7	9003414 19834 0
	210	207 x 80 x 81	196 x 69 x 73	990	74,60	9003414 19836 4	9003414 19838 8	9003414 19837 1
Accessories		for size		Dimensions W x L x H (cm)		EAN Code		
Lid Storage Net		for all sizes		25 x 67 x 2		9003414 67010 5		
Suspension Basket Type D		140		48,5 x 50,5 x 20		9003414 67073 0		
Suspension Basket Type E		170		59 x 50,5 x 20		9003414 67074 7		
Suspension Basket Type C		210		68,5 x 67 x 20		9003414 67072 3		
Castors		for all sizes		4,5 x 3,5 x 3,5, 2 pieces per package		9003414 67030 3		

LeisureTime Box	Size	Exterior Dimensions	Interior Dimensions	Volume (L)	Weight (kg)	EAN Code				
		W x L x H (cm)	W x L x H (cm)			White	Metallic Silver	Met. Quartz Grey	Met. Dark Grey	Metallic Bronze
	100	101 x 46 x 61	92 x 37,5 x 56	195	19,4	9003414 61010 1	9003414 64010 8	9003414 68010 4	9003414 65010 7	9003414 62010 0
	130	134 x 62 x 71	125 x 53,5 x 66	460	31,5	9003414 61040 8	9003414 64040 5	9003414 68040 1	9003414 65040 4	9003414 62040 7
	160 <sup>HIGH</sup>	160 x 79 x 83	151 x 70,5 x 78	830	47,5	9003414 61060 6	9003414 64060 3	9003414 68060 9	9003414 65060 2	9003414 62060 5
	180	181 x 79 x 71	172 x 70,5 x 66	800	47,7	9003414 61030 9	9003414 64030 6	9003414 68030 2	9003414 65030 5	9003414 62030 8
	200	201 x 79 x 83	192 x 70,5 x 77,5	1050	62,3	9003414 61090 3	9003414 64090 0	9003414 68090 6	9003414 65090 9	9003414 62090 2
Accessories		for size		Dimensions (cm)		EAN Code				
Lid Storage Net	for all sizes		25 x 67 x 2		9003414 67010 5					
Suspension Basket, Type A	100, 160, 180, 200		67 x 34 x 20		9003414 67070 9					
Suspension Basket, Type B	130		54,5 x 50 x 20		9003414 67071 6					
Suspension Basket, Type C	160, 180, 200		68,5 x 67 x 20		9003414 67072 3					
Parcel Box Kit	for all sizes		16,5 x 26,5 x 5		9003414 67020 4					

Parcel Box	Size	Exterior Dimensions	Interior Dimensions	Volume (L)	Weight (kg)	EAN Code				
		W x L x H (cm)	W x L x H (cm)			White	Metallic Silver	Met. Quartz Grey	Met. Dark Grey	Met. Bronze
	100	101 x 46 x 61	92 x 37,5 x 56	195	19,9	9003414 61910 4	9003414 64910 1	9003414 68910 7	9003414 65910 0	9003414 62910 3

MiniGarage	Size	Exterior Dimensions	Interior Dimensions	Foundation Dimensions	Weight (kg)	EAN Code	
		W x L x H (cm)	W x L x H (cm)	W x L (cm)		Metallic Silver	Metallic Dark Grey
	L	145 x 203 x 150	140 x 195 x 143,5	145 x 203	109,4	9003414 55040 7	9003414 56040 6
Accessories		Dimensions W x L x H (cm)			EAN Code		
Aluminium Floor Frame*	140 x 198 x 4			9003414 41032 9			
Ground Anchor**	4 pieces per package (8 pieces are needed in total)			9003414 41004 6			
Aluminium Floor Panels*	131,6 x 189,7 x 0,2			9003414 48032 2			
SmartBase*	140 x 198 x 18			9003414 43938 2			
SmartBase <sup>PLUS</sup> *	140 x 198 x 65			9003414 43439 4			
Shelf Set*	77 x 26,8 x 14 per shelf, incl. shelf supports			9003414 45013 4			
Bike Rail*	17,9 x 199,9 x 139,5			9003414 49014 7			
Electric Mounting Panel*	72 x 2,1 x 28			9003414 46039 3			
LED Light	44 x 4 x 1,5			9003414 46041 6			

\*Please note that the size of the MiniGarage has changed. The accessories only fit the "Model 2023 / Size L" with the dimensions 145 x 203 x 150 cm. Please check carefully that you have the correct size to use the accessory properly.

\*\*If the floor frame is laid directly on a gravel base (approx. 10 cm gravel, without foundation or slabs), ground anchors are required for securing to the ground. Storm resistance must be ensured by the customer.

Alex*	Exterior Dimensions	Interior Dimensions	Volume (L)	Weight (kg)	EAN Code		
	W x L x H (cm)	W x L x H (cm)			Metallic Silver	Metallic Quartz Grey	Metallic Dark Grey
	80 x 88 x 129	74,4 x 80 x 124,7	740	53,7	9003414 53063 8	9003414 58068 8	9003414 54064 4
If 3 or more Alex* wheelee bin boxes are ordered, a quantity discount is given.							
Left door hinge					9003414 59065 6	9003414 59065 6	9003414 59065 6
Accessories					Metallic Silver	Metallic Quartz Grey	Metallic Dark Grey
Connecting Element	For 2 Alex* units (one connection)			9003414 53067 6	9003414 58067 1	9003414 54067 5	
	For 3 Alex* units (two connections)			9003414 53069 0	9003414 58069 5	9003414 54069 9	
Matching Cylinder Locks	For 2 Alex* units			9003414 50040 2	9003414 50040 2	9003414 50040 2	
	For 3 Alex* units			9003414 50041 9	9003414 50041 9	9003414 50041 9	
Shelves	72 x 43,5 x 7			9003414 45030 1	9003414 45030 1	9003414 45030 1	
Shelf Support Rails	122 x 3 x 3			9003414 46022 5	9003414 46022 5	9003414 46022 5	





Alex® Duo	Exterior Dimensions	Interior Dimensions	Volume	Weight	EAN Code		
	W x L x H (cm)	W x L x H (cm)	(L)	(kg)	Metallic Silver	Metallic Quartz Grey	Metallic Dark Grey
	Door opening: 129 x 118 cm (W x H)						
	148 x 88 x 129,5	142 x 79 x 128	1436	57,1	9003414 <b>53090 4</b>	9003414 <b>58090 9</b>	9003414 <b>54090 3</b>
Accessories	Dimensions W x L x H (cm)			EAN Code			
<b>Floor Kit</b> (threshold ramp, aluminium floor plate*, aluminium floor frame**)	142 x 94 x 4			9003414 <b>57094 8</b>			
Note: If the floor frame is laid directly on a gravel base (approx. 10 cm gravel, without foundation or slabs), ground anchors are required for securing to the ground. Storm resistance must be ensured by the customer. For Alex® Duo: a total of 8 pieces necessary.							
Ground Anchor	53 x 4,5, 4 pieces per package			9003414 <b>41004 6</b>			
Shelf Support Rails	166 x 12 x 8,5, 2 pieces per package			9003414 <b>46024 9</b>			
Shelves	56 x 26 x 17,3, 2 pieces per package			9003414 <b>45040 0</b>			
Shelves (deep)	56 x 44,5 x 17,3, 2 pieces per package			9003414 <b>45060 8</b>			
*Aluminium floor panels: 2 mm aluminium checker plate. Aluminium floor frame required for optimal installation. Underlayment with a fill or XPS hard foam boards in a thickness of approx. 2-3 cm recommended (not included in the scope of delivery).							
**Aluminium floor frame: Aluminium square tubing (40 x 40 mm) with corner joints and fixing material (screws)							

## BikeLift® for Wall Mounting

BikeLift*	Variant	Exterior Dimensions	Weight	EAN Code
		W x L x H (cm)	(kg)	Metallic Dark Grey
	<b>Standard</b>	16 x 38 x 180	9,5	9003414 <b>49054 3</b>
	<b>Swivel Mount</b>	16 x 53 x 182	13	9003414 <b>49055 0</b>
Accessories				EAN Code
Electric Socket Mounting Panel	can be combined with all variants	10 x 12 x 4	0,2	9003414 <b>49059 8</b>

Fits almost any bike. Check your bike: [www.biohort.com/bikelift](http://www.biohort.com/bikelift)

## Special Solutions

Door variants for HighLine®, Panorama® and AvantGarde® garden sheds	Door opening	EAN Code		
	W x H (cm)	Metallic Silver	Metallic Quartz Grey	Metallic Dark Grey
<b>Standard Door with Left Door Hinge</b>	(not available for double doors), please note on the order "left door hinge"			
	76 x 182	9003414 <b>89001 5</b>	9003414 <b>89001 5</b>	9003414 <b>89001 5</b>
<b>Additional Door Double</b>	(not with AvantGarde®)			
	155 x 182	9003414 <b>83004 2</b>	9003414 <b>88004 7</b>	9003414 <b>84004 1</b>
Special Solution SmartBase <sup>PLUS</sup>				EAN Code
<b>Extension</b>				
	For ground screw extension tube with screw, washer and nut. Max. extension approx. 500 mm	1 piece per package	9003414 <b>43411 0</b>	

# Planting Bed

Raised Bed	Size	Exterior Dimensions	Interior Dimensions	Volume	Weight	EAN Code		
		W x L x H (cm)	W x L x H (cm)	(L)	(kg)	Metallic Silver	Metallic Quartz Grey	Metallic Dark Grey
	<b>1x0,5</b>	102 x 53 x 77	95 x 46 x 77	340	34,6	9003414 <b>64012</b> 2	9003414 <b>68012</b> 8	9003414 <b>65012</b> 1
	<b>1x1</b>	102 x 102 x 77	95 x 95 x 77	695	43,2	9003414 <b>64005</b> 4	9003414 <b>68005</b> 0	9003414 <b>65005</b> 3
	<b>1,5x0,5</b>	152 x 53 x 77	145 x 46 x 77	515	41,3	9003414 <b>64028</b> 3	9003414 <b>68028</b> 9	9003414 <b>65028</b> 2
	<b>1,5x1</b>	152 x 102 x 77	145 x 95 x 77	1060	49,9	9003414 <b>64018</b> 4	9003414 <b>68018</b> 0	9003414 <b>65018</b> 3
	<b>1,5x1,5</b>	152 x 152 x 77	145 x 145 x 77	1620	56,6	9003414 <b>64048</b> 1	9003414 <b>68048</b> 7	9003414 <b>65048</b> 0
	<b>2x0,5</b>	201 x 53 x 77	194 x 46 x 77	685	51,2	9003414 <b>64022</b> 1	9003414 <b>68022</b> 7	9003414 <b>65022</b> 0
	<b>2x1</b>	201 x 102 x 77	194 x 95 x 77	1450	59,8	9003414 <b>64015</b> 3	9003414 <b>68015</b> 9	9003414 <b>65015</b> 2
	<b>2x2</b>	201 x 201 x 77	194 x 194 x 77	2900	76,4	9003414 <b>64035</b> 1	9003414 <b>68035</b> 7	9003414 <b>65035</b> 0
	<b>L2x1</b>	201 x 201 x 77	194 x 194 x 77	2180	82,6	9003414 <b>64025</b> 2	9003414 <b>68025</b> 8	9003414 <b>65025</b> 1
	<b>4x1</b>	397 x 102 x 77	391 x 96 x 77	3742	123	9003414 <b>64085</b> 6	9003414 <b>68085</b> 2	9003414 <b>65085</b> 5

Accessories	for size	Dimensions W x L x H (cm)	Metallic Silver	Metallic Quartz Grey	Metallic Dark Grey
Intermediate Floor	<b>1x0,5</b>	98 x 51 x 3			9003414 <b>65042</b> 8
	<b>1x1</b>	98 x 100 x 3			9003414 <b>65046</b> 6
	<b>1,5x0,5</b>	147 x 51 x 3			9003414 <b>65045</b> 9
	<b>2x0,5</b>	196 x 51 x 3			9003414 <b>65043</b> 5
	<b>1,5x1</b>	147 x 98 x 3			9003414 <b>65049</b> 7
	<b>2x1</b>	196 x 100 x 3			9003414 <b>65047</b> 3
	<b>4x1</b>	394 x 100 x 3			9003414 <b>65039</b> 8
Cold Frame Extension	<b>2x1</b>	200 x 101 x 23	9003414 <b>64013</b> 9	9003414 <b>68013</b> 5	9003414 <b>65013</b> 8
Slug Guard	<b>1x0,5</b>	110 x 61 x 4,2	9003414 16349 2	9003414 16351 5	9003414 16350 8
	<b>1x1</b>	110 x 110 x 4,2	9003414 16370 6	9003414 16372 0	9003414 16371 3
	<b>1,5x0,5</b>	160 x 61 x 4,2	9003414 16367 6	9003414 16369 0	9003414 16368 3
	<b>2x0,5</b>	209 x 61 x 4,2	9003414 16355 3	9003414 16357 7	9003414 16356 0
	<b>1,5x1</b>	160 x 61 x 4,2	9003414 16364 5	9003414 16366 9	9003414 16365 2
	<b>2x1</b>	209 x 110 x 4,2	9003414 16352 2	9003414 16354 6	9003414 16353 9
	<b>1,5x1,5</b>	160 x 160 x 4,2	9003414 16361 4	9003414 16363 8	9003414 16362 1
Skirting	<b>2x2</b>	209 x 209 x 4,2	9003414 16373 7	9003414 16375 1	9003414 16374 4
	<b>1x0,5</b>	115 x 66,4 x 6,3	9003414 16399 7	9003414 16401 7	9003414 16400 0
	<b>1x1</b>	115 x 115 x 6,3	9003414 16396 6	9003414 16398 0	9003414 16397 3
	<b>1,5x0,5</b>	164 x 66,4 x 6,3	9003414 16393 5	9003414 16395 9	9003414 16394 2
	<b>2x0,5</b>	214 x 66,4 x 6,3	9003414 16382 9	9003414 16384 3	9003414 16383 6
	<b>1,5 x 1</b>	164 x 115 x 6,3	9003414 16390 4	9003414 16392 8	9003414 16391 1
	<b>2x1</b>	214 x 115 x 6,3	9003414 16379 9	9003414 16381 2	9003414 16380 5
	<b>1,5x1,5</b>	164 x 164 x 6,3	9003414 16385 0	9003414 16387 4	9003414 16386 7
	<b>2x2</b>	214 x 214 x 6,3	9003414 16376 8	9003414 16378 2	9003414 16377 5
	<b>L2x1</b>	214 x 214 x 6,3	9003414 16408 6	9003414 16410 9	9003414 16409 3
Trellis (1 pc.) (With L-size is 1 pc. also possible)	<b>for 1 m side</b>	102 x 4 x 91	9003414 16436 9	9003414 16438 3	9003414 16437 6
	<b>for 1,5 m side</b>	152 x 4 x 91	9003414 16439 0	9003414 16441 3	9003414 16440 6
	<b>for 2 m side</b>	201 x 4 x 91	9003414 16442 0	9003414 16444 4	9003414 16443 7
	<b>for 4 m side</b>	399 x 4 x 91	9003414 92340 9	9003414 92342 3	9003414 92341 6
Trellis L Form (2 pcs.)	<b>1x1</b>	102 x 102 x 91	9003414 16445 1	9003414 16447 5	9003414 16446 8
	<b>1,5x1,5</b>	152 x 152 x 91	9003414 16448 2	9003414 16450 5	9003414 16449 9
	<b>2x2, L2x1</b>	201 x 201 x 91	9003414 16451 2	9003414 16453 6	9003414 16452 9
Privacy Screen (1 pc.) (With L-size is 1 pc. also possible)	<b>for 1 m side</b>	102 x 4 x 91	9003414 16457 4	9003414 16459 8	9003414 16458 1
	<b>for 1,5 m side</b>	152 x 4 x 91	9003414 16460 4	9003414 16462 8	9003414 16461 1
	<b>for 2 m side</b>	201 x 4 x 91	9003414 16463 5	9003414 16465 9	9003414 16464 2
	<b>for 4 m side</b>	399 x 4 x 91	9003414 92343 0	9003414 92345 4	9003414 92344 7
Privacy Screen L Form (2 pcs.)	<b>1x1</b>	102 x 102 x 91	9003414 16466 6	9003414 16468 0	9003414 16467 3
	<b>1,5x1,5</b>	152 x 152 x 91	9003414 16469 7	9003414 16471 0	9003414 16470 3
	<b>2x2, L2x1</b>	201 x 201 x 91	9003414 16472 7	9003414 16474 1	9003414 16473 4
Privacy Screen with Glass Panels (1 pc.) (With L-size is 1 pc. also possible)	<b>for 1 m side</b>	102 x 4 x 91	9003414 16475 8	9003414 16477 2	9003414 16476 5
	<b>for 1,5 m side</b>	152 x 4 x 91	9003414 16478 9	9003414 16480 2	9003414 16479 6
	<b>for 2 m side</b>	201 x 4 x 91	9003414 16481 9	9003414 16483 3	9003414 16482 6
	<b>for 4 m side</b>	399 x 4 x 91	9003414 92346 1	9003414 92348 5	9003414 92347 8
Privacy Screen L Form with Glass Panels (2 pcs.)	<b>1x1</b>	102 x 102 x 91	9003414 16484 0	9003414 16486 4	9003414 16485 7
	<b>1,5x1,5</b>	152 x 152 x 91	9003414 16487 1	9003414 16489 5	9003414 16488 8
	<b>2x2, L2x1</b>	201 x 201 x 91	9003414 16490 1	9003414 16492 5	9003414 16491 8

Belvedere®	Size	Exterior Dimensions	Interior Dimensions	Volume	Weight	EAN Code		
		W x L x H (cm)	W x L x H (cm)	(L)	(kg)	Metallic Silver	Metallic Quartz Grey	Metallic Dark Grey
<b>MINI</b>		Height: 45 cm						
	<b>50<sup>MINI</sup></b>	53 x 53 x 45	46 x 46 x 45	42	19,8	9003414 15888 7	9003414 15875 7	9003414 15853 5
	<b>100<sup>MINI</sup></b>	102 x 53 x 45	95 x 46 x 45	90	27,3	9003414 15887 0	9003414 15874 0	9003414 15852 8
	<b>150<sup>MINI</sup></b>	152 x 53 x 45	145 x 46 x 45	135	33,7	9003414 15885 6	9003414 15872 6	9003414 15850 4
	<b>200<sup>MINI</sup></b>	201 x 53 x 45	194 x 46 x 45	180	39,9	9003414 15882 5	9003414 15869 6	9003414 15847 4
	<b>L100<sup>MINI</sup></b>	102 x 102 x 45	95 x 95 x 45	130	38,8	9003414 15878 8	9003414 15865 8	9003414 15856 6
	<b>L150<sup>MINI</sup></b>	152 x 152 x 45	145 x 145 x 45	225	53,5	9003414 15877 1	9003414 15864 1	9003414 15855 9
	<b>L200<sup>MINI</sup></b>	201 x 201 x 45	194 x 194 x 45	315	66,5	9003414 15876 4	9003414 15863 4	9003414 15854 2
<b>MIDI</b>		Height: 61 cm						
	<b>50<sup>MIDI</sup></b>	53 x 53 x 61	46 x 46 x 61	42	23,8	9003414 15940 2	9003414 15919 8	9003414 15904 4
	<b>100<sup>MIDI</sup></b>	102 x 53 x 61	95 x 46 x 61	90	32,9	9003414 15939 6	9003414 15918 1	9003414 15903 7
	<b>150<sup>MIDI</sup></b>	152 x 53 x 61	145 x 46 x 61	135	40,6	9003414 15937 2	9003414 15915 0	9003414 15901 3
	<b>200<sup>MIDI</sup></b>	201 x 53 x 61	194 x 46 x 61	180	48,3	9003414 15934 1	9003414 15911 2	9003414 15898 6
	<b>L100<sup>MIDI</sup></b>	102 x 102 x 61	95 x 95 x 61	130	46,4	9003414 15930 3	9003414 15907 5	9003414 15891 7
	<b>L150<sup>MIDI</sup></b>	152 x 152 x 61	145 x 145 x 61	225	64	9003414 15929 7	9003414 15906 8	9003414 15890 0
	<b>L200<sup>MIDI</sup></b>	201 x 201 x 61	194 x 194 x 61	315	79,8	9003414 15927 3	9003414 15905 1	9003414 15889 4
<b>MAXI</b>		Height: 77 cm						
	<b>50<sup>MAXI</sup></b>	53 x 53 x 77	46 x 46 x 77	42	27,8	9003414 16021 7	9003414 16008 8	9003414 15953 2
	<b>100<sup>MAXI</sup></b>	102 x 53 x 77	95 x 46 x 77	90	38,5	9003414 16020 0	9003414 16007 1	9003414 15952 5
	<b>150<sup>MAXI</sup></b>	152 x 53 x 77	145 x 46 x 77	135	46,6	9003414 16018 7	9003414 16005 7	9003414 15950 1
	<b>200<sup>MAXI</sup></b>	201 x 53 x 77	194 x 46 x 77	180	57,5	9003414 16015 6	9003414 16002 6	9003414 15947 1
	<b>L100<sup>MAXI</sup></b>	102 x 102 x 77	95 x 95 x 77	130	54	9003414 16011 8	9003414 15998 3	9003414 15943 3
	<b>L150<sup>MAXI</sup></b>	152 x 152 x 77	145 x 145 x 77	225	73,6	9003414 16010 1	9003414 15997 6	9003414 15942 6
	<b>L200<sup>MAXI</sup></b>	201 x 201 x 77	194 x 194 x 77	315	93	9003414 16009 5	9003414 15996 9	9003414 15941 9
<b>Accessories</b>		for size		Dimensions W x L x H (cm)		Metallic Silver	Metallic Quartz Grey	Metallic Dark Grey
Slug Guard		<b>100</b>		110 x 61 x 4,2		9003414 16349 2	9003414 16351 5	9003414 16350 8
		<b>150</b>		160 x 61 x 4,2		9003414 16367 6	9003414 16369 0	9003414 16368 3
		<b>200</b>		209 x 61 x 4,2		9003414 16355 3	9003414 16357 7	9003414 16356 0
Skirting		<b>50</b>		66,4 x 66,4 x 6,3		9003414 16402 4	9003414 16404 8	9003414 16403 1
		<b>100</b>		115 x 66,4 x 6,3		9003414 16399 7	9003414 16401 7	9003414 16400 0
		<b>150</b>		164 x 66,4 x 6,3		9003414 16393 5	9003414 16395 9	9003414 16394 2
		<b>200</b>		214 x 66,4 x 6,3		9003414 16382 9	9003414 16384 3	9003414 16383 6
		<b>L100</b>		115 x 115 x 6,3		9003414 16414 7	9003414 16416 1	9003414 16415 4
		<b>L150</b>		164 x 164 x 6,3		9003414 16411 6	9003414 16413 0	9003414 16412 3
		<b>L200</b>		214 x 214 x 6,3		9003414 16405 5	9003414 16407 9	9003414 16406 2
Planter Insert		<b>1 piece</b>		50 x 50 x 18			9003414 16424 6	
		<b>2 piece</b>		50 x 50 x 18			9003414 16427 7	
		<b>3 piece</b>		50 x 50 x 18			9003414 16430 7	
		<b>4 piece</b>		50 x 50 x 18			9003414 16433 8	
Trellis (1 pc.) (With L-size is 1 pc. also possible)		<b>100</b>		102 x 4 x 91		9003414 16436 9	9003414 16438 3	9003414 16437 6
		<b>150</b>		152 x 4 x 91		9003414 16439 0	9003414 16441 3	9003414 16440 6
		<b>200</b>		201 x 4 x 91		9003414 16442 0	9003414 16444 4	9003414 16443 7
Trellis for L Form (2 pcs.) (for each of the long sides)		<b>L100</b>		102 x 102 x 91		9003414 16445 1	9003414 16447 5	9003414 16446 8
		<b>L150</b>		152 x 152 x 91		9003414 16448 2	9003414 16450 5	9003414 16449 9
		<b>L200</b>		201 x 201 x 91		9003414 16451 2	9003414 16453 6	9003414 16452 9
Privacy Screen (1 pc.) (With L-size is 1 pc. also possible)		<b>100</b>		102 x 4 x 91		9003414 16457 4	9003414 16459 8	9003414 16458 1
		<b>150</b>		152 x 4 x 91		9003414 16460 4	9003414 16462 8	9003414 16461 1
		<b>200</b>		201 x 4 x 91		9003414 16463 5	9003414 16465 9	9003414 16464 2
Privacy Screen for L Form (2 pcs.) (for each of the long sides)		<b>L100</b>		102 x 102 x 91		9003414 16466 6	9003414 16468 0	9003414 16467 3
		<b>L150</b>		152 x 152 x 91		9003414 16469 7	9003414 16471 0	9003414 16470 3
		<b>L200</b>		201 x 201 x 91		9003414 16472 7	9003414 16474 1	9003414 16473 4
Privacy Screen with Glass Panels (1 pc.) (With L-size is 1 pc. also possible)		<b>100</b>		102 x 4 x 91		9003414 16475 8	9003414 16477 2	9003414 16476 5
		<b>150</b>		152 x 4 x 91		9003414 16478 9	9003414 16480 2	9003414 16479 6
		<b>200</b>		201 x 4 x 91		9003414 16481 9	9003414 16483 3	9003414 16482 6
Privacy Screen with Glass Panel for L Form (2 pcs.) (for each of the long sides)		<b>L100</b>		102 x 102 x 91		9003414 16484 0	9003414 16486 4	9003414 16485 7
		<b>L150</b>		152 x 152 x 91		9003414 16487 1	9003414 16489 5	9003414 16488 8
		<b>L200</b>		201 x 201 x 91		9003414 16490 1	9003414 16492 5	9003414 16491 8

\*Dimensions of planter insert (W x L x H): 50 x 50 x 18 cm; size 50: 1 pc. possible; size 100: 2 pcs. possible; size 150, L100: 3 pcs. possible; size 200: 4 pcs. possible; size L150: 5 pcs. possible; size L200: 7 pcs. possible





DaVinci*	Version	Exterior Dimensions W x L x H (cm)	EAN Code			
			Metallic Silver	Metallic Quartz Grey	Metallic Dark Grey	
	1	Terrace border with trellis: 1,5 x 1,5m corner with trellis, graduated on both sides 0,5m MIDI, 1m MINI	299,5 x 299,5 x 168	9003414 17335 4	9003414 17346 0	9003414 17345 3
	2	Terrace border with privacy screen: 1,5m MAXI with privacy screen, 1 x 1m corner with trellis on one side, 0,5m MIDI, 0,5m MINI	250 x 201 x 168	9003414 17347 7	9003414 17349 1	9003414 17348 4
	3	Flower bed: 0,5m MINI, 0,5m MIDI and 1m MAXI	201 x 53 x 77	9003414 17350 7	9003414 17352 1	9003414 17351 4

Configure your own DaVinci\* planter box system now! [www.biohort.com/configurator](http://www.biohort.com/configurator)

## Gardening Helpers

MonAmi*	Exterior Dimensions	Interior Dimensions	Volume	Weight	EAN Code
	W x L x H (cm)	W x L x H (cm)	(L)	(kg)	Metallic Dark Grey
	102 x 102 x 84	95 x 95 x 74	725	62,9	9003414 <b>65026 8</b>

Charly*	Size	Exterior Dimensions	Weight	EAN Code
		W x L x H (cm)	(kg)	
	2	78 x 90 x 49	13,5	9003414 <b>68082 1</b>

WoodStock*	Size	Exterior Dimensions*	Interior Dimensions	Foundation Dimensions	Volume	Weight	EAN Code		
		W x L x H (cm)	W x L (cm)	W x L (cm)	(m³)	(kg)	Metallic Silver	Metallic Quartz Grey	Metallic Dark Grey
	150	157 x 102 x 199	142 x 70	155 x 83	2,1	48,5	9003414 <b>35010 6</b>	9003414 <b>38010 3</b>	9003414 <b>37010 4</b>
	230	229 x 102 x 199	214 x 70	227 x 83	3,1	54,1	9003414 <b>35020 5</b>	9003414 <b>38020 2</b>	9003414 <b>37020 3</b>
	300	300,7 x 102 x 199	286 x 70	299 x 83	4	64,7	9003414 <b>35040 3</b>	9003414 <b>38040 0</b>	9003414 <b>37040 1</b>
Accessories	for size	Dimensions W x L x H (cm)							
Aluminium Floor Panels	150	141,5 x 69,5 x 0,2				9,9	9003414 <b>48010 0</b>		
	230	213,5 x 69,5 x 0,2				14	9003414 <b>48080 3</b>		
	300	285,5 x 69,5 x 0,2				17,3	9003414 <b>48013 1</b>		
Back Wall	150	145,5 x 1,1 x 196,5				15,7	9003414 <b>35012 0</b>	9003414 <b>38012 7</b>	9003414 <b>37012 8</b>
	230	217,5 x 1,1 x 196,5				22,5	9003414 <b>35022 9</b>	9003414 <b>38022 6</b>	9003414 <b>37022 7</b>
	300	288,6 x 1,1 x 196,5				32,9	9003414 <b>35042 7</b>	9003414 <b>38042 4</b>	9003414 <b>37042 5</b>
Door Package	150	157 x 5 x 171				24	9003414 <b>35001 4</b>	9003414 <b>38001 1</b>	9003414 <b>37001 2</b>
	230	229 x 5 x 171				29	9003414 <b>35002 1</b>	9003414 <b>38002 8</b>	9003414 <b>37002 9</b>
Note: If the floor frame is laid directly on a gravel base (approx. 10 cm gravel, without foundation or slabs), ground anchors are required for securing to the ground. Storm resistance must be ensured by the customer. For sizes 150, 230: 6 pcs. in total; for size 300: 10 pcs. in total are necessary.									
Ground Anchor	4 pieces per package						9003414 <b>41004 6</b>		
	6 pieces per package						9003414 <b>41006 0</b>		

\*highest point, incl. roof overhang

## CleanLine Cleaning Agents

CleanLine		Volume	EAN Code	
	<b>Universal Cleaner</b>	With strong dissolving power against grease, oil, algae and dirt of all kinds. Forms a short-term dirt and water-repellent surface. Perfect for removing fingerprints after assembly.	1000 ml	9003414 <b>99000 5</b>
	<b>Conservation</b>	Leaves a water and dirt-repellent protective film (lotus effect). Protect your Biohort product from environmental influences and at the same time ensure a silky matt shine.	750 ml	9003414 <b>99100 2</b>
	<b>Saver Set</b>	(Universal Cleaner + Conservation)	1000 ml + 750 ml	9003414 <b>99200 9</b>

# Biohort stands for “Life in the Garden”

NEW





The product of the year: the Biohort Pergola.

Your specialist dealer:



follow us:

-  biohort
-  biohort
-  Biohort GmbH
-  Biohort GmbH

Here you  
can find our  
non-binding  
recommended  
retail prices:



**Biohort GmbH**  
Pürnstern 43, 4120  
Neufelden, Austria  
+43 7282 / 7788 0  
office@biohort.at  
[www.biohort.com](http://www.biohort.com)

Technical modifications,  
misprints and colour  
deviations reserved.  
ZD021070 - EN

